



Apollo365

Module-based UV LED Panel

Super Large Coverage

Adjustable Intensity

Replaceable LED Module



Customized UV LED Quantity



Super Large Coverage



Adjustable Intensity



Easy Maintenance

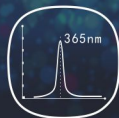

Safe Spectrum



Excellent Cooling Ability



High Intensity



Economical

Multiple LED Configuration

- Flood & Spot UV Module Interchangeable
- Customize UV Intensity & Coverage
- 5-level UV Intensity

LED Module

- High Intensity & Uniform Beam
- Optical Lens + UV Filter
- Repair Friendly

Rugged Design

- Aviation Grade Aluminum Housing
- Finned Heat Dissipating Design
- Mechanical Cooling & Fans Cooling

Features >>>

- Instant maximum output without pre-heating.
- Switch function between UV light and white light.
- LED module-based design with excellent maintainability.
- Safe and pure UV-A centering at 365nm.
- UV filter ensuring visible light less than 5 Lux.
- Horizontally and longitudinally expandable with standard connectors.
- 100% solid state circuit ensuring working properly in strong magnetic field.



✓ ASTM E3022 ✓ ASTM E1444 ✓ ASTM E1417



Apollo365

Module-based UV LED Panel

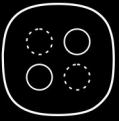

Customized UV LED Quantity

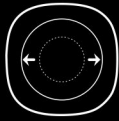

Super Large Coverage



Adjustable Intensity



Easy Maintenance

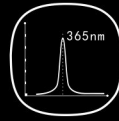

Safe Spectrum



Excellent Cooling Ability

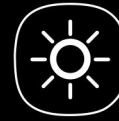

High Intensity



Economical

Super Large Coverage

Adjustable Intensity

Replaceable LED Module



Apollo365 Module-based UV LED Panel

Rugged Design

- Aviation Grade Aluminum Housing
- Finned Heat Dissipating Design
- Mechanical Cooling & Fans Cooling

Multiple Mounting Options

- Chain Hanging
- Angle-adjustable Bracket
- Expandable with Standard Connectors

LED Module

- High Intensity & Uniform Beam
- Optical Lens + UV Filter
- Easy Maintenance & Repair

DIY Panel

- Multiple LED Configuration Options
- UV LED Module (Flood & Spot) + White LED Module

✓ ASTM E3022

✓ ASTM E1444

✓ ASTM E1417



Customize Your Ideal UV LED Panel!



Spot



UV LED Module

Flood



UV LED Module

Flood



White Light LED Module



How much do know about LED UV lamp?

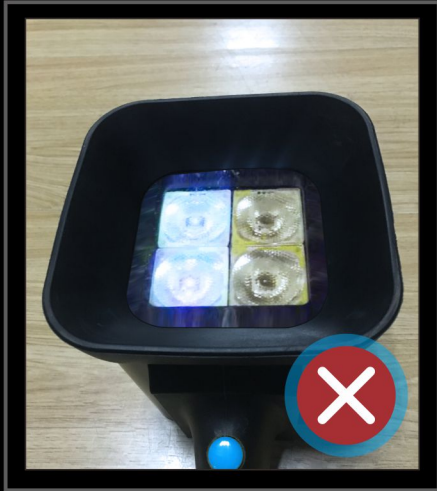

Does LED UV Lamp really last for 10,000 - 50,000 hours as stated?

The lifespan of LED UV lamp primarily depends on the lifespan of the LEDs of it. The stated lifespan of LED UV lamps on the market is usually based on the theoretical data from the laboratory where the environmental temperature of the LEDs to be tested is strictly controlled at 25°C (77°F). However, the working environment, temperature and the ventilation conditions of factory workshops are much harsher than that of the laboratory, so the real lifespan of LED is much less than its statement. Based on our market research, the lifespan of LED in workshops is about 1.5-2 years and usually the expected value in tropic and subtropic zones is even lower.



Can I repair or replace the LED when it blows off?

LEDs should be welded onto the board with special equipment due to its unique characteristics, which is nearly impossible for the end users to repair it by themselves. In addition, most LED UV lamps on the market are designed with series connected LEDs in a single circuit board. If a single LED stops working, the other LEDs will blow off subsequently due to the fact that the broken LED chip leads to varied electrical resistance and voltage redistribution for each LED. For the repair of most LED UV lamps on the market, the whole LED board with many LEDs in series will be replaced with a new one, which is time, effort and money consuming. In one word, the repair of the LED UV lamp is much more complex than that of the bulb-based mercury lamp.



The World's First UV LED Lamp with Replaceable Single Module



Long-lasting



Easy Maintenance



Large Coverage



Economical

To fix above problems of the UV LED lamp on the market, the world's first completely module-based LED UV lamp, Apollo 365 is launched by CHiNDT with the feature of easy repair and maintenance! The design of Apollo 365 originates from the bulb-based mercury lamp: When one LED module blows off, replace with a new LED module, and back to work immediately.



Make the Maintenance Easier

ATOM™

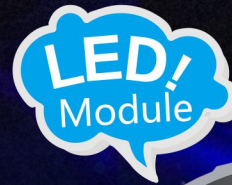

Larger Coverage



Easy Maintenance

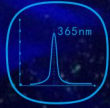

Safe Spectrum



High Intensity







Economical



Apollo 365 UV LED panel is a fully modularized product. LED modules is to Apollo 365 what atoms to molecule, therefore, LED module is named ATOM™. ATOM™ is simply fixed on the circuit board with 2 screws, which is convenient for operators to replace a new LED module once it blows off.

ATOM™ has three types: Flood UV LED module-ATOM™ Flood, Spot UV LED module-ATOM™ Spot and White LED module-ATOM™ White. ATOM™ Flood and ATOM™ Spot are interchangeable based on your needs. You can customized your Apollo 365 by choosing different ATOM™ combinations to ensure the ideal UV intensity and coverage!

Technical Data >>>

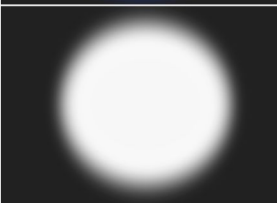
ATOM™ Model	Part No.	Figure	Features	Beam
ATOM™ Spot	AP-E-01		<ul style="list-style-type: none"> • High UV Intensity • Anti-aging Optical Lens 	
ATOM™ Flood	AP-E-02		<ul style="list-style-type: none"> • Large Coverage • Uniform Beam • Anti-aging Optical Lens 	
ATOM™ White	AP-E-03		<ul style="list-style-type: none"> • Large Coverage • Uniform Beam 	

Specially Designed for Apollo365

----- Patent Pending -----



Apollo365-L

LED Module-based Large Coverage



Apollo365/L overhead panel utilizes the state-of-art LED technology and makes it a great tool for fluorescent MT, PT and leak detection. The standard version consists of 8 UV LEDs and 2 white LEDs, which ensures high UV intensity and large coverage. Made of aviation grade aluminum alloy, Apollo365/L will endure the harshest working conditions. Apollo365/L highlights its rugged design, excellent cooling ability, waterproof and dustproof performance. The unique fearture of Apollo365/L is its module-based design. Its illumination area is up to 540*520mm!

Apollo365/L abandons the design of many LEDs welded on the same board in series. Each LED of Apollo365/L is encapsulated as an independent unit - ATOM™. ATOM™ Flood and ATOM™ Spot are interchangalbe to make your preferred Apollo365/L with the desired UV intensity and coverage area. Besides, the electrical board is 5-level adjustable, which offers you more intensity possibilities.

UV Intensity >>>

Model	LED Combination	Layout	Intensity
AP365-L	8 UV LEDs 2 White LEDs		3500-4600μw/cm ²

Technical Data >>>

Item	Technical Data
LED Source	8 UV LEDs, 2 White LEDs
Wavelength	365-370nm
Dimension	400*200*86mm
Coverage	540*520mm
Intensity	3500-4600uw/cm ²
Visible Light	<5Lux
Weight	4.5Kg
Power Input	170-260V, 50/60Hz
Power Output	24V, 5A
Rated Power	UV-A 4W*8

Dimension >>>

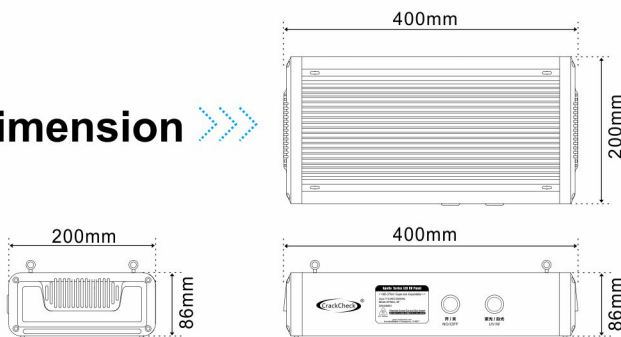

Irradiance Profile >>>

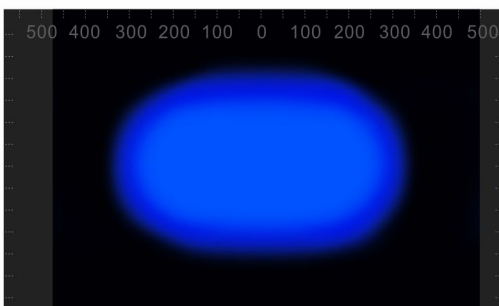

Coverage: 540mm*520mm (at 38cm)

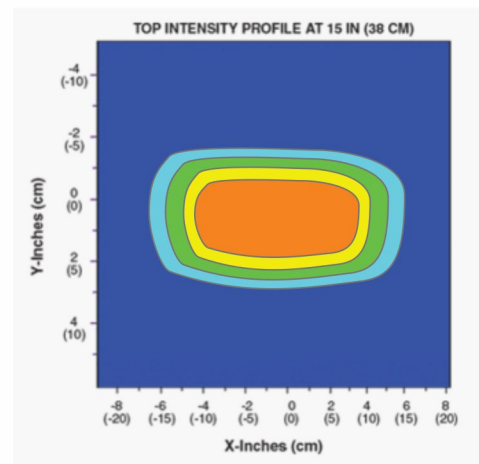

Packing List >>>



Apollo365 UV LED Panel



Mains Cable



Hanging Chain



Hanging Ring



Documentation
(COC, Operation Manual, etc.)

Apollo365-XL

LED Module-based Super Large Coverage



Apollo365/XL overhead panel utilizes the state-of-art LED technology and makes it a great tool for fluorescent MT, PT and leak detection. The standard version consists of 16 UV LEDs and 4 white LEDs, which ensures high UV intensity and large coverage. Made of aviation grade aluminum alloy, Apollo365/XL will endure the harshest working conditions. Apollo365/XL highlights its rugged design, excellent cooling ability, waterproof and dustproof performance. The unique feature of Apollo365/XL is its module-based design. Its illumination area is up to 730*520mm!

Apollo365/XL abandons the design of many LEDs welded on the same board in series. Each LED of Apollo365/XL is encapsulated as an independent unit - ATOM™. ATOM™ Flood and ATOM™ Spot are interchangeable to make your preferred Apollo365/XL with the desired UV intensity and coverage area. Besides, the electrical board is 5-level adjustable, which offers you more intensity possibilities.

UV Intensity >>>

Technical Data >>>

Model	LED Combination	Layout	Intensity
AP365-XL	16 UV LEDs 4 White LEDs		4800-5700μw/cm²

Item	Technical Data
LED Source	16 UV LEDs, 4 White LEDs
Wavelength	365-370nm
Dimension	610*200*86mm
Coverage	730*520mm
Intensity	4800-5700uw/cm²
Visible Light	<5Lux
Weight	8Kg
Power Input	170-260V, 50/60Hz
Power Output	24V, 5A
Rated Power	UV-A 4W*16

Dimension >>>

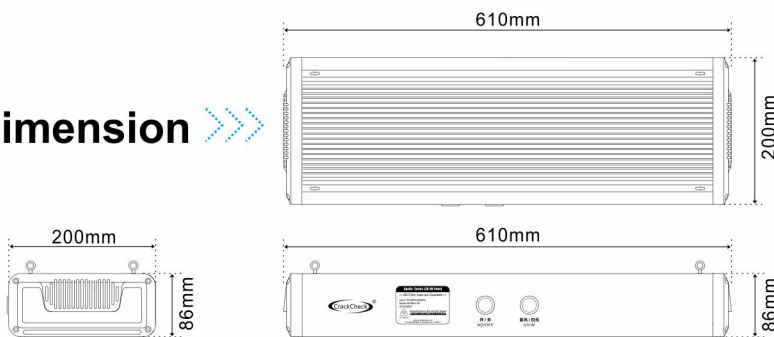

Irradiance Profile >>>

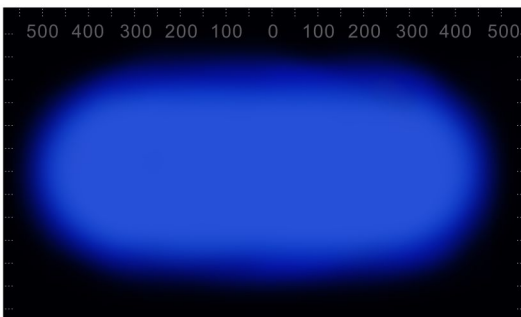

Coverage: 730mm*520mm (at 38cm)

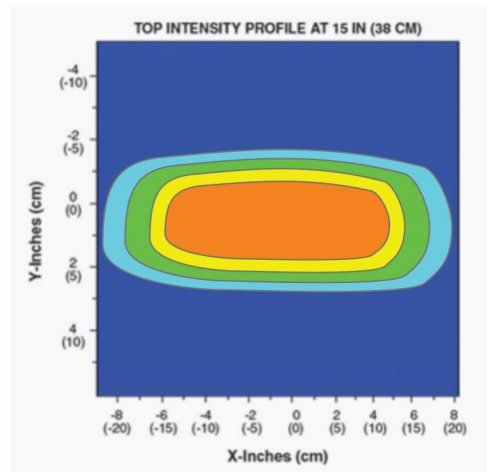

Packing List >>>



Apollo365 UV LED Panel



Mains Cable



Hanging Chain



Hanging Ring



Documentation
(COC, Operation Manual, etc.)



Apollo365

DIY Panel

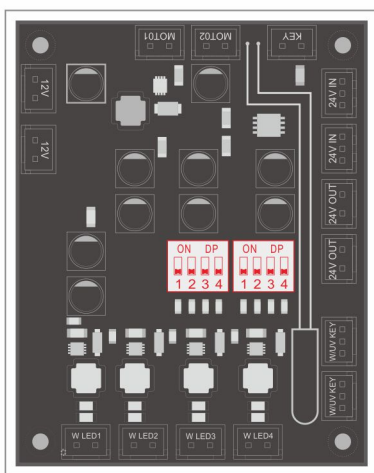

LED Current Driving Board

Adjust the UV Intensity

Level 0 (0 ON, 8 OFF)
Current: 500mA

Level 1 (2 ON, 6 OFF)
Current: 600mA

Level 2 (4 ON, 4 OFF)
Current: 800mA

Level 3 (6 ON, 2 OFF)
Current: 1000mA

Level 4 (8 ON, 0 OFF)
Current: 1200mA

- There are two drive boards on Apollo365-XL, shall adjust two boards simultaneously to keep them at the same intensity level.
- Lifespan of LED module depends on current level going through it.

Intensity Table

Model	Combination	Layout	Module Type	Level 0	Level 1	Level 2	Level 3	Level 4
AP365-L	6 UV LEDs 4 White LEDs		Spot	6400µw/cm²	6900µw/cm²	7300µw/cm²	7600µw/cm²	8100µw/cm²
	8 UV LEDs 2 White LEDs		Flood	3400µw/cm²	3700µw/cm²	4000µw/cm²	4300µw/cm²	4600µw/cm²
	10 UV LEDs		Flood	4150µw/cm²	4550µw/cm²	4940µw/cm²	5340µw/cm²	5680µw/cm²

Model	Combination	Layout	Module Type	Level 0	Level 1	Level 2	Level 3	Level 4
AP365-XL	16 UV LEDs 4 White LEDs		Flood	4800µw/cm²	5000µw/cm²	5300µw/cm²	5500µw/cm²	5700µw/cm²
	20 UV LEDs		Flood	/	/	/	/	/

Need higher UV intensity?

- 1 ATOM™ Flood and ATOM™ Spot and Spot module are interchangeable and can be installed on the same board, which offers more combination of UV intensity and coverage area to meet specific inspection demand.
- 2 Get the highest UV output by adjusting the current level. The UV intensity is designed up to 10,000uw/cm at 38 cm.

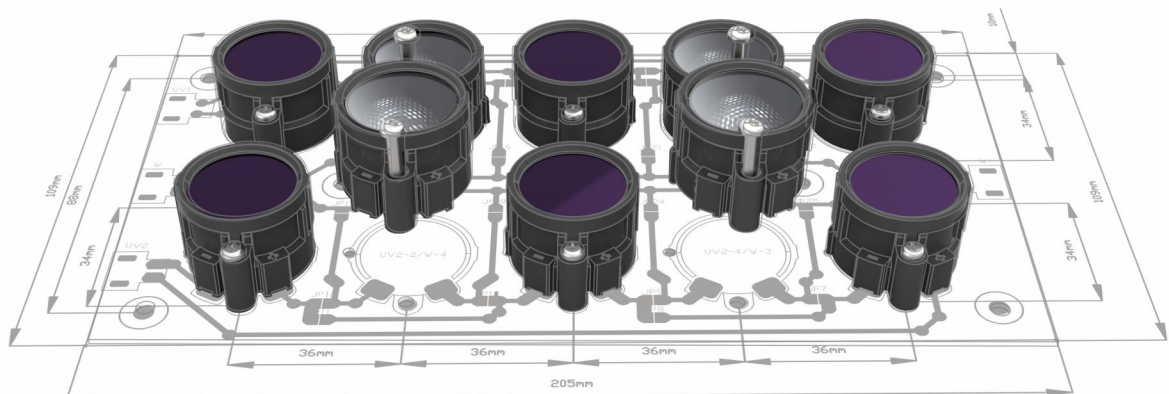

Mounting Option >>>

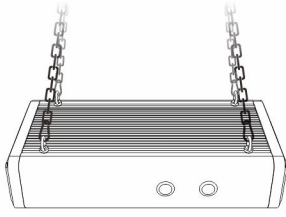

Hanging Chain

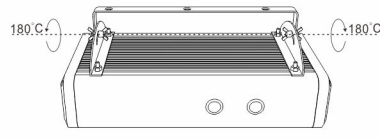

Bracket (Angle Adjustable)



① Standard Aluminum Connector for horizontal extension

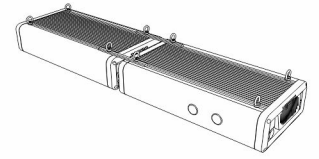

② Standard Aluminum Connector for longitudinal extension

Assembling Drawing >>>

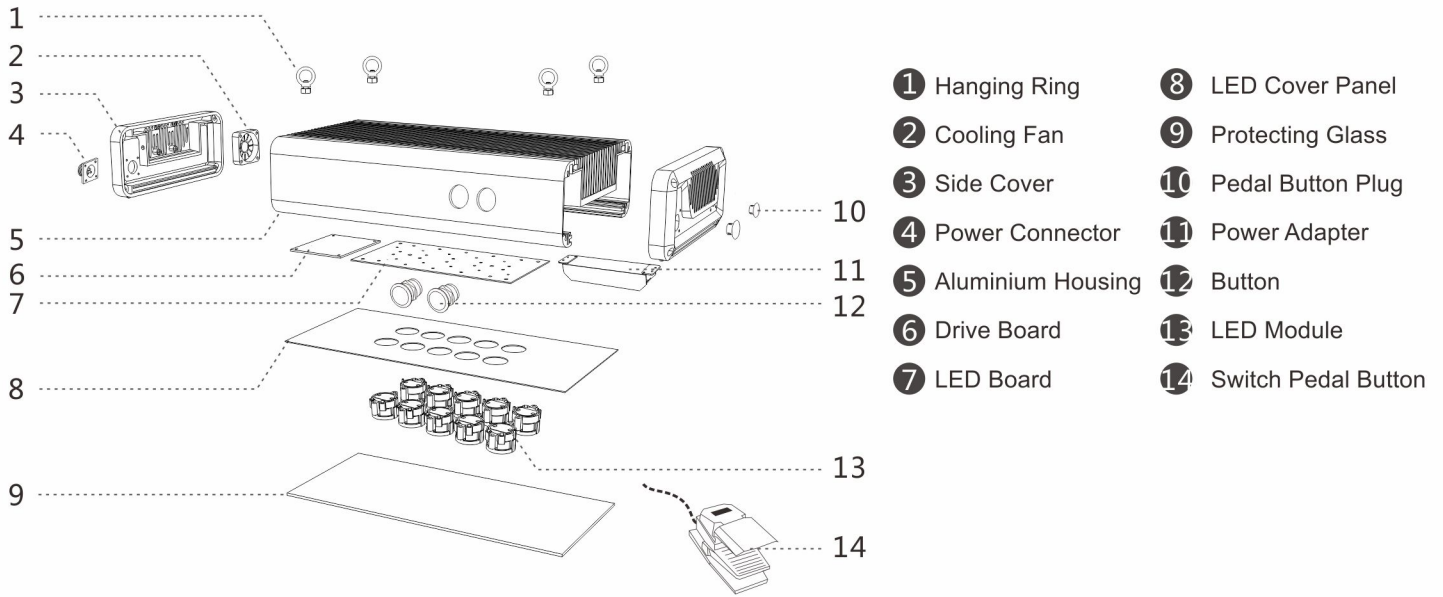

- ① Hanging Ring
- ② Cooling Fan
- ③ Side Cover
- ④ Power Connector
- ⑤ Aluminium Housing
- ⑥ Drive Board
- ⑦ LED Board
- ⑧ LED Cover Panel
- ⑨ Protecting Glass
- ⑩ Pedal Button Plug
- ⑪ Power Adapter
- ⑫ Button
- ⑬ LED Module
- ⑭ Switch Pedal Button

Part List >>>

UV LED Module ATOM™ Spot	UV LED Module ATOM™ Flood	White LED Module ATOM™ White	Power Adapter	Drive Board	Cooling Fan
 AP-E-01 (Spare Part)	 AP-E-02 (Spare Part)	 AP-E-03 (Spare Part)	 AP-D-01	 AP-C-02	 AP-D-05 (Spare Part)
 AP-C-01	 AP-E-01	 AP-D-02 (Spare Part)	 AP-D-04 (Spare Part)	 AP-D-10 (Optional)	 AP-D-08 (Optional)
 AP-D-09 (Optional)	 AP-C-05 (Optional)	 AP-C-06 (Optional)	 AP-C-07 (Optional)	 AP-A-01	 AP-C-04

Apollo365

Repair Instruction

MUST KEEP THE POWER-OFF DURING THE WHOLE PROCESS

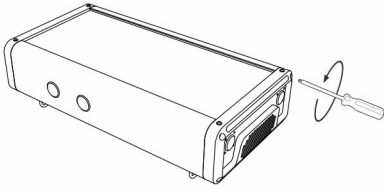

1 Use hex key to unscrew the screws counterclockwise and remove the side cover.

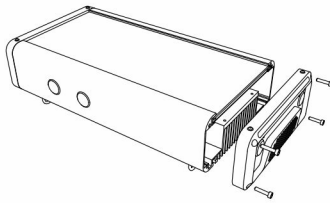

2 Remove the side cover carefully and prevent the connecting cable from being pulled apart.

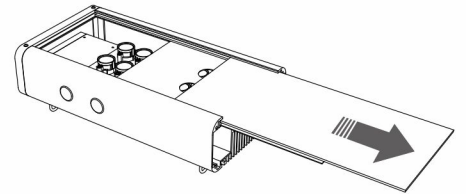

3 Pull out the protecting glass and the LED cover.

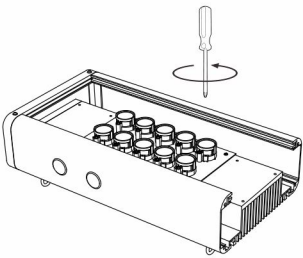

4 Use the phillips screwdriver to unscrew the broken LED module counterclockwise.

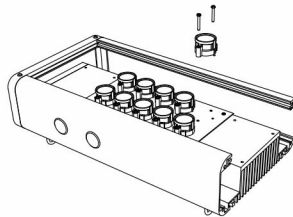

5 Remove the broken LED module vertically carefully.

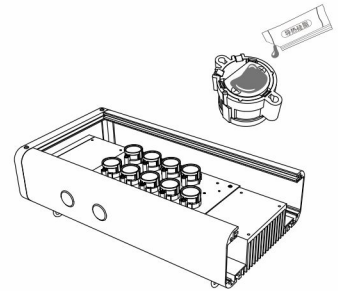

6 Apply the silicone thermal grease on the bottom of the new LED module, but keep the metal contact CLEAR (No grease on it). Clean the metal contact if needed.

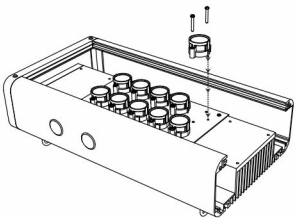

7 Locate the check point and put the new LED module on the LED board.

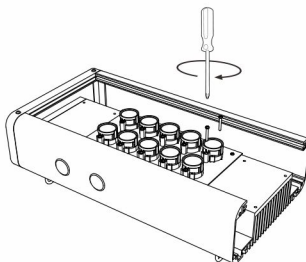

8 Use phillips screwdriver to fix the new LED module.

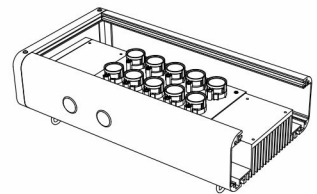

9 Turn on the lamp to check if the LED modules work.

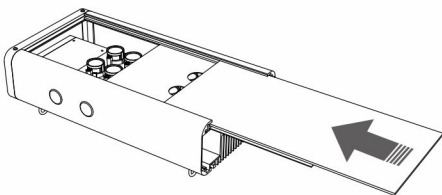

10 Put the LED cover and the protecting glass back to position.

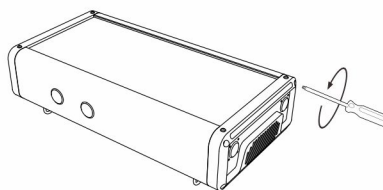

11 Fix the side cover.

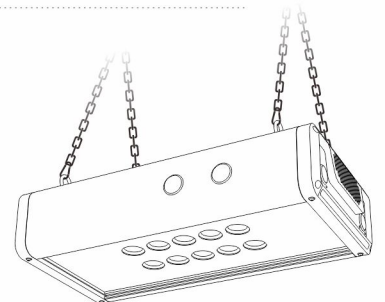

12 Check and test, done!