

VERSITRON[®]
Rockwell Hardness Testing System

Operation Manual
AT130-RDS & AT130-SRDS



TRADEMARKS

AMETEK is a registered trademark of AMETEK, Inc. NEWAGE TESTING INSTRUMENTS is a trademark of AMETEK, Inc. Other trademarks are the property of their respective owners.

SUPPORT

AMETEK Newage Testing Instruments,
Inc.
820 Pennsylvania Blvd
Feasterville PA 19053
USA

Tel: (215) 355-6900
Fax: (215) 354-1803
newage.info@ametek.com

AMETEK Measurement and Calibration
Technologies
8600 Somerset Drive
Largo, FL 33773
USA

Tel: +1 (727) 536 7831
Tel: +1-800-527-9999 (within USA only)
www.newage.com

CAUTION!

HIGH FORCES ARE OFTEN INVOLVED WITH THE HARDNESS TESTING PROCESSES.

The machine is powered by mains supply voltage

The machine is a Class 1 product, which means it **MUST** be connected to a mains socket outlet with a **PROTECTIVE EARTH CONNECTION**

Do not position the equipment so that it is difficult to operate the mains disconnect device (machine mains inlet socket).

If the equipment is used in a manner not specified by the manufacturer, the protection provided by the equipment may be impaired

To maintain all aspects of the specification, only Newage approved accessories connections and components should be used

Strictly adhere to all specified safety procedures

PLEASE READ THIS MANUAL BEFORE USING THE HARDNESS TESTING MACHINE.

LIST OF ICONS USED IN THIS MANUAL



WARNING

The raised hand icon warns of a situation or condition that may lead to personal injury or death. Do not proceed until the warning is read and thoroughly understood. Warning messages are shown in bold type.



DANGEROUS VOLTAGE

The lightning icon warns of the presence of an uninsulated dangerous voltage within the product enclosure that might be of sufficient magnitude to cause serious shocks or death. Never open the enclosures unless you are an authorized and qualified NEWAGE TESTING INSTRUMENTS' service personnel. Never open any enclosure when power is connected to the system or its components.



CAUTION

The exclamation point icon indicates a situation or condition that may lead to equipment malfunction or damage. Do not proceed until the caution message is read and thoroughly understood. Caution messages are shown in bold type.



NOTE

The note icon indicates additional or supplementary information about the action, activity or concept. Notes are shown in bold type.

DECLARATION OF CONFORMITY.



DECLARATION OF CONFORMITY

According to ISO/IEC 17050-1:2004

Manufacturer's Name: Ametek, Inc.

Manufacturer's Address: 8600 Somerset Drive
Largo, FL 33773
USA

Declares under sole responsibility that the product as originally delivered

Product Name: Versitron Rockwell Hardness Tester
Model Number: Advanced Digital Rockwell Hardness Tester Series
Product Options: 230VAC, N and T Test Frames, MT2 Electric Drive Systems

Complies with the essential requirements of the following applicable European Directives, and carries the CE marking accordingly:

Machinery Directive 2006/42/EC

Standard	EHSR
EN ISO 12100:2010	Harmonized
EN 60204-1:2006	Harmonized

Low Voltage Directive 2006/95/EC

Standard	EHSR
EN 61010-1:2010	Harmonized

EMC Directive 2004/108/EC

Standard	EHSR
EN 55011: 2009, +A1: 2010	Harmonized
EN 61326-1: 2013	Harmonized

And conforms with the following product standards:

Standard	Description	Class	Status	EHSR
EN 55011: 2009, +A1: 2010	Conducted Emissions	Class A	Pass	Harmonized
EN 55011: 2009, +A1: 2010	Radiated Emissions	Class A	Pass	Harmonized
EN 61326-1:2013 (IEC 61000-4-2: 2009)	Electrostatic Discharge		Pass (1)	Harmonized
EN 61326-1:2013 (IEC 61000-4-3: 2006 +A1: 2008 +A2: 2010)	Radiated Immunity		Pass	Harmonized
EN 61326-1:2013 (IEC 61000-4-4: 2012)	Electrical Fast Transient / Burst		Pass (1)	Harmonized
EN 61326-1:2013 (IEC 61000-4-5: 2006)	Surge Immunity		Pass	Harmonized
EN 61326-1:2013 (IEC 61000-4-6: 2009)	Conducted RF Immunity		Pass	Harmonized
EN 61326-1:2013 (IEC 61000-4-11: 2004)	Voltage Dips and Interruptions		Pass (2)	Harmonized

(1) Criteria B (2) Criteria C

I hereby declare that the equipment named above has been designed to comply with the relevant sections of the above referenced specifications. The unit complies with all essential requirements of the Directives.

USA Signatory:

Division Vice President, NA Operations & Engineering
David K Porter, P.E.

AMETEK Inc.
8600 Somerset Drive, FL 33773, USA
+1 800 527 9999

European Signatory:

Division Vice President & Business Unit Manager
Joel Frie

AMETEK Denmark A/S
Gydevang 32-34, 3450 Allerød, Denmark
+45 4816 8000

05 June 2015

TABLE OF CONTENTS

1.0 INTRODUCTION	6	6.0 INDIRECT CALIBRATION	54
2.0 GENERAL SAFETY	7	7.0 SPECIFICATIONS	59
2.1 ELECTRICAL SAFETY	8	7.1 Technical Specifications AT130-(T-Stand)	59
3.0 TEST METHOD	9	7.2 T-Stand Overall Dimensions	59
3.1 ASTM E18: Rockwell Hardness Testing.....	9	7.3 Technical Specifications AT130-(N-Stand).....	60
3.2 Top-loading and test Surface Referencing.....	9	7.4 N-Stand Overall Dimensions.....	60
3.3 Unique Benefits to Keep In Mind	10	7.5 Test Head Technical Specifications.....	61
4.0 INSTALLATION & SETUP	11	7.6 Test head Overall Dimensions.....	62
4.1 Test Stand Installation.....	11	7.7 DataView Output Specifications.....	63
4.2 Positioning Stands.....	13	7.8 Standard Accessories	64
4.3 Bolting the Bench Stands	14	7.9 Options and Other Accessories	64
4.4 Installing the Operating Lever	15	8.0 MAINTENANCE & TROUBLESHOOTING	67
4.5 Installing the Test Head	16	8.1 Maintenance Procedures	67
4.6 Automatic Systems.....	18	8.2 Troubleshooting “What Not To Do”	67
4.7 Dual Head Systems.....	18	8.3 Troubleshooting “What To Do” Before Calling Newage	67
5.0 OPERATION	19	8.4 Pre-Troubleshooting Checklist.....	67
5.1 General Procedures	19	8.5 Troubleshooting Checklist.....	68
5.2 Basic Operation	19	9.0 VERSITRON FACTORY SERVICE & SHIPPING INSTRUCTIONS	71
5.3 All Manual or Automatic Bench Stands	20	10.0 REFERENCE TABLES, ASTM E18	73
5.4 Changing Scales.....	22	10.1 Rockwell Scale.....	73
5.5 Changing The Hardness Scale Displayed	23	10.2 Minimum Thickness	73
5.6 Changing Indenters	23	10.3 Round Correction	74
5.7 Changing & Adjusting Load	24	10.4 Hardness Conversion Chart, Rockwell C Hardness Range.....	75
5.8 Load Lock	28	10.5 Hardness Conversion Chart, Rockwell B Hardness Range.....	76
5.9 Clamping Shield Operation.....	29	10.6 Test Blocks Hardness Ranges (Indirect Verification)	77
5.10 Checking Vee Anvil Alignment.....	30	APPENDIX A: Motor Drive Options	78
5.11 T-Stand; Vee Anvil Adjustment.....	30	APPENDIX B: Automatic Head-Height Adjustment Option	79
5.12 N-Stand; Vee Anvil Adjustment.....	32	APPENDIX C: Calibration & Service Support.....	80
5.13 Indenter Shroud, Clamping Shield Options	32	WARRANTY	81
5.14 Testing Tapered Parts	32		
5.15 Testing without Anvil Stage	33		
5.16 User Interface (U.I.) Control Unit	35		
5.17 U.I. Control Unit Installation.....	35		
5.18 Powering Up	35		
5.19 Basic Operation	36		
5.20 Test Screen	37		
5.21 Statistics Screen	38		
5.22 File Screen	41		
5.23 Setup Screen	43		
a. Hardness Scale.....	44		
b. Time at Load	44		
c. Measurement to Average	45		
d. High Tol. & Low Tol.....	45		
e. Conversion	46		
f. Roundness	47		
5.24 Advanced Settings.....	48		
5.25 Technician Screen.....	50		
5.26 User Settings.....	53		

1.0 INTRODUCTION

The Versitron family of testers uses the most advanced mechanical and digital components of the market to make your testing as simple as possible.

Due to their unique design, these testers are significantly different to install and operate than any other testers. PLEASE READ THROUGH THIS MANUAL CAREFULLY. When beginning to set up and operate your tester, follow through sections for the general instructions and then for those sections dealing with your specific model.

Section Two is crucial to read and understand, as it describes the safety factors and practices involved when operating this equipment.

Section Three is important to read because it clarifies exactly what methods these testers use, how they operate and how it can benefit you.

Section Four is for installation.

Section Five covers operation for all test modes, stands and included is a checklist for correct operation.

Section Six describes the Indirect Calibration process.

Section Seven identifies all the parts and components described later in the manual as well as the specifications.

Section Eight covers all maintenance procedures and provides a troubleshooting guide, if you run into problems.

Section Nine lists service help and shipping procedures if factory service is required.

Section Ten may be helpful as a reference for various aspects of testing. It includes tables from the ASTM standard E18 for Rockwell testing.

Appendices include descriptions of optional components or software that may have been purchased with this system.



2.0 GENERAL SAFETY

General safety precautions must be followed when using this NEWAGE TESTING INSTRUMENTS product. Failure to observe precautions and warnings may result in damage to the equipment or injury to personnel.

It is understood that safety rules within companies vary. If a conflict exists between the material contained in all NEWAGE TESTING INSTRUMENTS' User's Guides and the rules of a company using a NEWAGE TESTING INSTRUMENTS product, the more stringent rules should take precedence.

Safety Considerations

The Versitron is completely enclosed and provides no potentially hazardous outputs. Safety considerations are related to the power connections and physical mountings.

Electronic and mechanical components housed within the Versitron casings are to be serviced by authorized NEWAGE TESTING INSTRUMENTS' representatives only.

The final and full compliance with the requirements of the Machinery Directive 2006/42/EC will be dependent on the industry, application, material (to be tested), location (of the use), etc. The final user must take the necessary steps to ensure the safety of the operator, other people, machine and properties by providing guards, shields, screen, adequate lighting, adequate ventilation, etc. Furthermore, when the machine is installed, wired and ready for its intended use the final user must conduct the final Risk Assessment on the machine, including all such safety measures (shield, guard, etc.), to satisfy the requirements of Machinery Directive and EHSR (Essential Health and Safety Requirements).



CRUSH HAZARD!

Be aware, the Versitron Test Head unit is a moving element that has the potential to crush objects during normal operation. Please ensure your hands are kept away from the Versitron moving head area.



When designing custom fixtures!

Ensure fixtures load ratings exceed the Versitron maximum load rating. I.e. If load rating is 1kN the fixtures must be designed to exceed 1kN load.

2.1 ELECTRICAL SAFETY

1. The Versitron Test Machine has been designed to meet the requirements of BS EN 61010-1:2010 Safety requirements for electrical equipment for measurement, control and laboratory use.
2. The user manual contains some information and warnings, which have to be followed by the user to ensure the safe operation and to keep the machine in safe condition.
3. The machine has been designed for indoor use.
4. This machine complies with electrical safety grade Class 1, which means that it is “earthed apparatus” and requires the mains plug to contain a protective earth terminal. The mains plug must only be inserted in a socket outlet provided with a protective earth contact. The protective action must not be negated by the use of an extension cord without a protective conductor.
5. Make sure that only fuses with the required rated current and of the specified type are used for replacement. The use of makeshift fuses and the short-circuiting of fuse holders is prohibited.
6. There are no user serviceable parts within the machine.
7. The machine must be disconnected from all voltage sources before it is opened for any adjustments, replacement, maintenance or repair.
8. Capacitors inside the machine may still be charged even if the machine has been disconnected from all voltage sources.
9. Any adjustment, maintenance or repair of the opened machine connected to the mains supply voltage should be avoided as far as possible but if inevitable, it must only be carried out by a skilled person who is aware of the hazards involved.
10. Only use safety approved power cords that come with the Versitron test machines.

3.0 TEST METHOD

3.1 ASTM E18: Rockwell Hardness Testing

This tester operates according to ASTM E18 standard in all particulars. It is used by virtually every large automotive, aerospace and defense manufacturer in the nation.

3.2 Top-loading and Test Surface Referencing

The Versitron has two unique features: top-loading and test surface referencing. At the start of the test the entire indenter descends approximately 3/32" to contact the test specimen surface. As the preload and full loads are applied, the indenter shroud contacts the specimen surface.

This shroud establishes a reference point against which the depth of penetration is compared.

This feature reduces or eliminates the effects of deflection of the test stand and specimen under load. With standard testers, deflection in the specimen, elevating screw, or the frame components invalidates the test.

Furthermore, a clamping shield can be used to firmly fix a specimen into position without special fixturing. Since the clamping shield is fixed to the test stand independently of the test head which holds all the measuring and loading components, there is no effect on the test results.

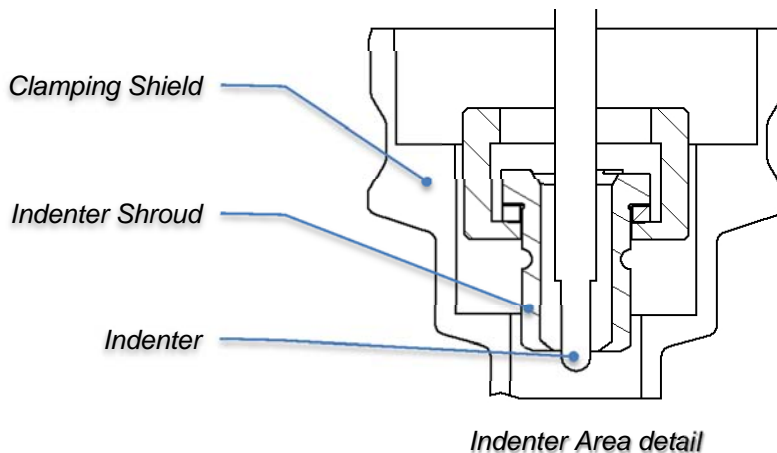

3.3 Unique Benefits to Keep In Mind

These features of top loading and test-surface referencing provide a number of unique benefits:

Transportability - The tester does not need to be leveled before testing, nor does it need a firm foundation. This means the tester can be placed on a wheeled cart and carried to different test locations such as different furnaces in a heat treating facility.

Operation in bad environments - Dirt, corrosion and oil on the underside of the specimen, anvil, or elevating screw don't produce bad test results (within certain limits). Even heavy vibration doesn't upset the test results. This means your maintenance is reduced, reliability is improved, and your tester operations are more flexible.

Reducing operator influence - Since the operator basically puts the part into position and pulls a lever or pushes a foot pedal, there is far less possibility of bad test technique affecting the test results. Virtually any operator can get good results right from the start.

Highest possible speed - Single-stroke testing in a couple of seconds, even on manually operated units makes for the fastest possible testing. There's no impact from the load cell and there's virtually no Setup time on large parts.

Lower service costs - Since the clamping shield protects the diamond from damage, there's less breakage expense. The tester can be calibrated in-house and factory service of the interchangeable test heads also reduces costs. Of course, field service is also available through the Newage service network.

4.0 INSTALLATION AND SETUP

4.1 Test Stand Installation

The Versitron machines are heavy machines and great care should be taken in choosing the location where is to be installed. Ensure the bench is capable of remaining firm and stable withstanding the combined weight of the machine and any accessories supplied. Please see the Specifications page (section 6.0) for the weight of the apparatus.

Suitable lifting equipment should be used when lifting the Versitron machine; i.e. a hydraulic floor hoist (2t capacity, recommended) and a polyester sling (5t. rating, recommended). Please ensure utmost care is taken when lifting this instrument, use safe working practices.



Ensure the sling is wrapped around this area of the machine (as shown).

*Lifting the Versitron machine
(BT130N shown)*

The tester is shipped in two crates, one containing the Stand with an Accessory Kit and one containing the Test Head.

Included in the Accessory Kit should be:

- Set of Allen wrenches
- 2" Vee anvil
- Spot anvil
- Test blocks
- Wrench to remove elevating unit
- Pin wrench
- Small Vee anvil
- 1/16" ball indenter
- Anvil base collet
- Calibration block
- Vinyl protective cover

Also included are:

- Operating lever (non-automatic testers only), in crate with stand.
- 3" flat anvil and clamping shield, installed on stand
- Diamond indenter installed on head



NOTE: Please make a careful visual inspection of all the parts made to ensure that there is no obvious transit damage.



NOTE: Please check that you have received all the parts that were ordered. If there is any damage, or parts missing, please report them to your authorized NEWAGE TESTING INSTRUMENTS representative.

Unpack all the materials. BT130T and BT130N stands are bolted to the base of the crate. Save the packing materials for possible future return shipping for factory service.

4.2 Positioning the Stands, Models BT130N & BT130T

The Versitron machine must be positioned such that the front can be easily accessed, the control unit and operating lever should not be obstructed and at the adequate height and reach so as to best ergonomically fitted for the end user.

The Versitron machines are heavy items and cannot normally tip over. However, the stand must be fixed to the working surface, as many parts can be cantilevered out from the working axis and create a moment. This measure also prevents the risk that users can pull or push against the frame and tip over the machine.

Position the test stand in the desired location. Screw in the height adjustment knob on BT130T stands. For bench models the base under the tester should provide a 3" wide hole directly underneath the acme thread elevating screw to permit the elevating screw to descend to its lowest position (see section 4.3). To position the tester over the hole, lower the elevating screw by turning the height adjusting wheel counter-clockwise. If the elevating screw is not properly centered over the hole, the elevating screw will only descend a few inches before the height adjusting wheel starts to ride up the elevating screw. Reposition the stand. The elevating screw will drop down when positioned properly.



*Bench Stand Positioning
(BT130T shown)*

4.3 Bolting the Bench Stands

It is required that the Versitron machines are secured to the bench using the 4 (M12) threaded holes that must be reached from underneath the base. The templates below show the location of the 4 holes as required on the workbench for the bolts clearance. A centered hole needs to be drilled out also for clearance of the Elevating Screw.

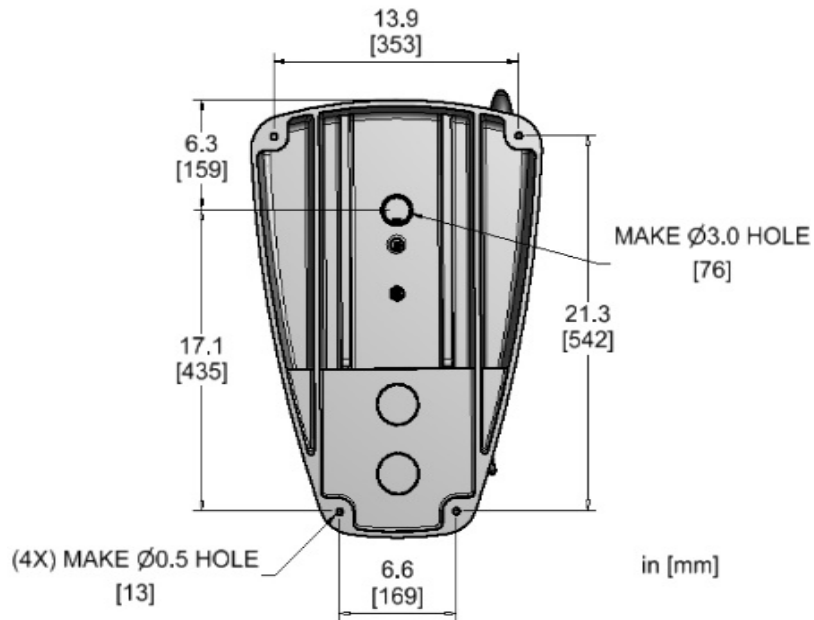

T-Stand underside view

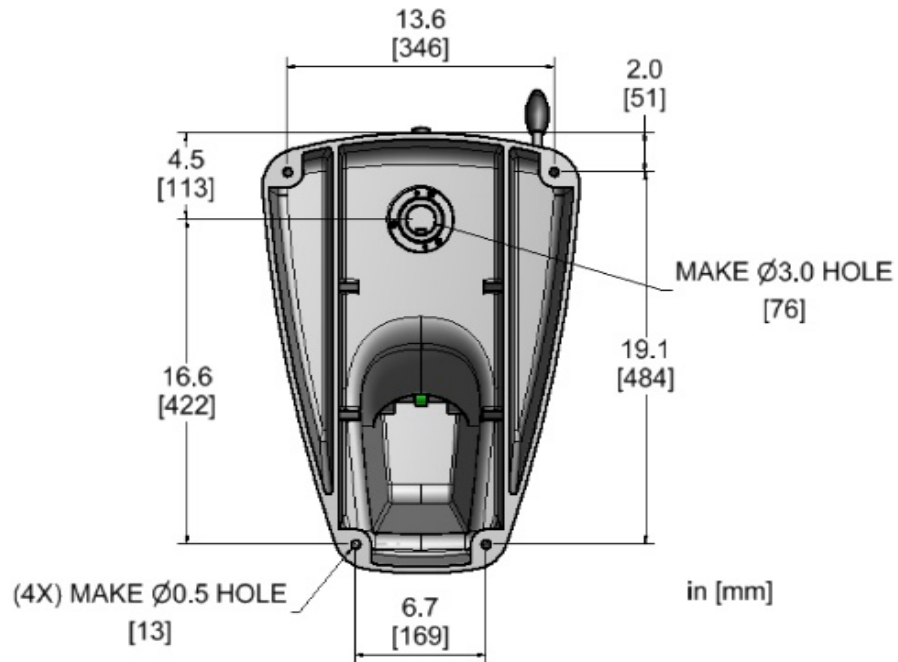

N-Stand underside view

4.4 Installing the Operating Lever (Non-Automatic Testers)

The operating lever should be slipped into the split lever casing. Tighten the thumbscrews on the casing finger-tight.

Slip the operating lever assembly onto the lever spine so the lever is leaning back about 10 degrees at the resting position. Install the lever screw and washer to tighten the lever assembly to the stand. The normal rest position of the lever is shown in the photo. (Note the top position setting.) If the lever is pressed against the stop (see arrow), it should slip with 10 pounds force on the end of the lever. The split casing acts as a clutch to prevent excessive force. It is normally set correctly at the factory but if it is too loose, tighten the Allen screw that tightens the split casing.

If the Allen set screw is set too tightly, a second stress reliever in the lever stop will slip. To realign it, slightly loosen the 3 holding screws and line up the red screw with the red dot on the collar. Resecure the 3 screws firmly.

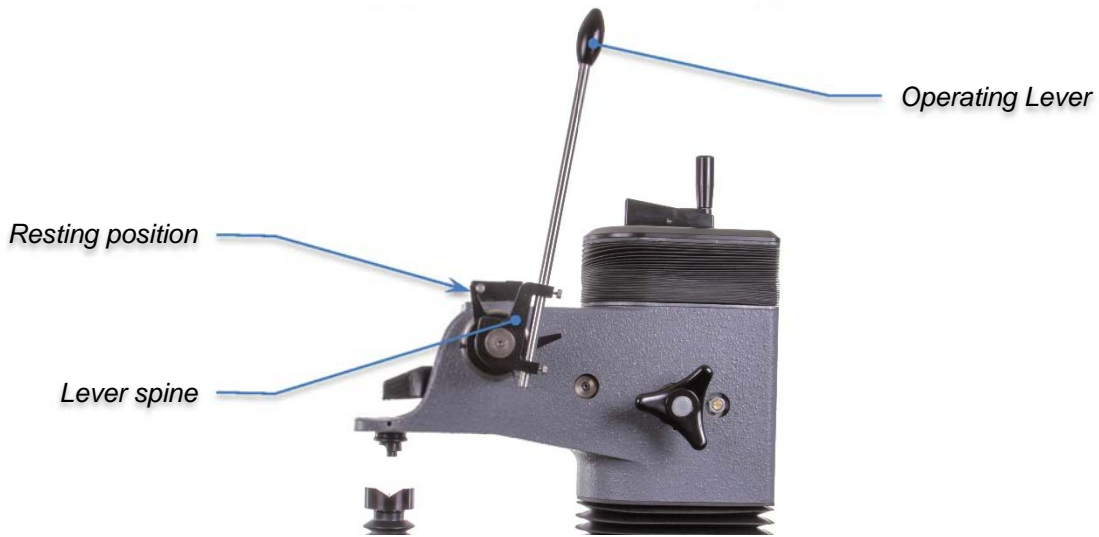

Installing Operating Lever

4.5 Installing the Test Head

All Test Heads are installed into the test stands in the same manner. They are designed for quick installation and removal. This feature facilitates scale changeover from regular to superficial Rockwell and facilitates service.

Make sure the area where the Test Head sits is clean. Lower the elevating screw. Remove the clamping shield. Remove side guards (motorized units). Loosen the head lock Allen screw.

Rotate the pressure knobs so that one is in line with the load plate. On all units there is a preload switch case next to one pressure knob. In this case, keep the case toward the front.

With the load plate facing the same direction as the stand, carefully set the Test Head into the stand with the indenter assembly over the indenter hole. Set the indenter assembly into the indenter hole area and lean the Test Head upright while settling the head into position. Be sure not to damage the indenter by making contact with the stand.



Installing the Test Head

Lift the pressure yoke and rotate the pressure knobs so the pressure yoke rests on each knob. (If a motor drive is installed, it may be necessary to push down on the top of the test head while rotating the pressure knobs in order to get enough clearance to be able to rotate the knobs.) Orient the load plate to face forward while holding the knobs into position. On manually operated units, pull the operating lever down to the stop position and tighten the head lock Allen screw while holding the lever down. On automatic units, press the top of the Test Head down by hand until it bottoms out, then tighten the head lock Allen screw. (To remove the Test Head the procedure is reversed.) The entire procedure should take a few seconds, once it has been repeated a few times.



Installing the Test Head

Attach all the connections at the back of the test head. They are all in labeled positions. Each connection is keyed so that only the proper male and female ends will fit. Attach the power cable and plug it into the power source. Attach the preload switch cable from the bottom of the test head. Attach a USB cable (optional) to a data collection computer, running DataView.

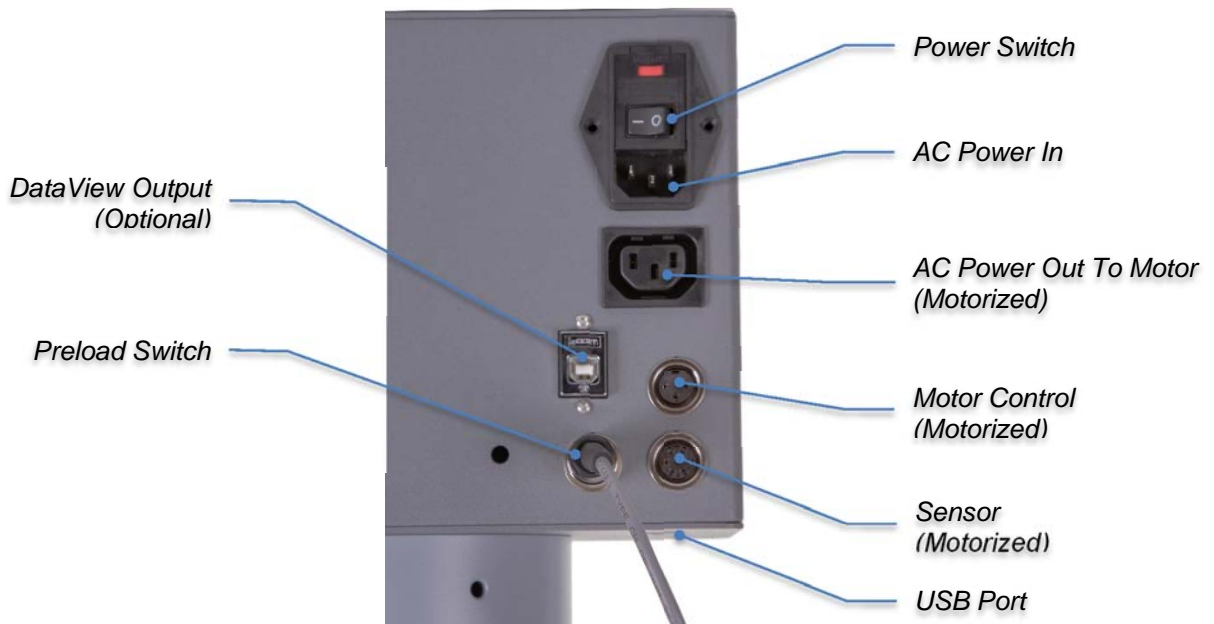

Rear Connections

The Versitron's Control Unit uses two ceramic high breaking capacity type fuses (20mm x 5mm). The two fuses are assembled into the power entry module fuse block, as shown below.



WARNING

If the fuses need to be replaced, ensure to replace them using the exact same type and rating as the ones supplied by the factory (see Technical Specifications section 6.6). DO NOT replace with higher or lower rated fuses.

4.6 Automatic Systems; Testers with -MT2 or -MT4 Option

Automatic Systems, are shipped already assembled. Be sure to plug in power cable running from the motor into the test head. Two additional cables need to be connected; one cable is for motor control and one for sensor signals.

4.7 Dual Head Systems -2DS Model

Dual digital head systems come with two complete electronic Test Heads. For installation and setup procedure, follow the instructions described in section 3.5. Remember to plug in all cables from the load canister to the electronic unit, to the power and optionally to the motor drive.

5.0 TESTER OPERATION

5.1 General Procedures

This is a top-loaded Rockwell Hardness Testing system. Therefore, with one downward lever motion the preload, zero set, and full load are applied automatically. Raising the lever to the reading position removes the full load and provides a hardness test result. Your anvil is only a means of support for the test piece, not a preload set. Therefore, the anvil is not sensitive to dirt or grease and less surface preparation is necessary on the opposite side of test surface than with other testers. In addition, test cycle time is reduced greatly, especially with parts of similar size, because the anvil height need not be adjusted from one test to the next.



NOTE: It is important that the tester only be used with the indenter shroud attached.



CAUTION

All operators must receive adequate training in basic operation before being allowed to use the machine. Additional copies of this manual are available from AMETEK Inc.

5.2 Basic Operation

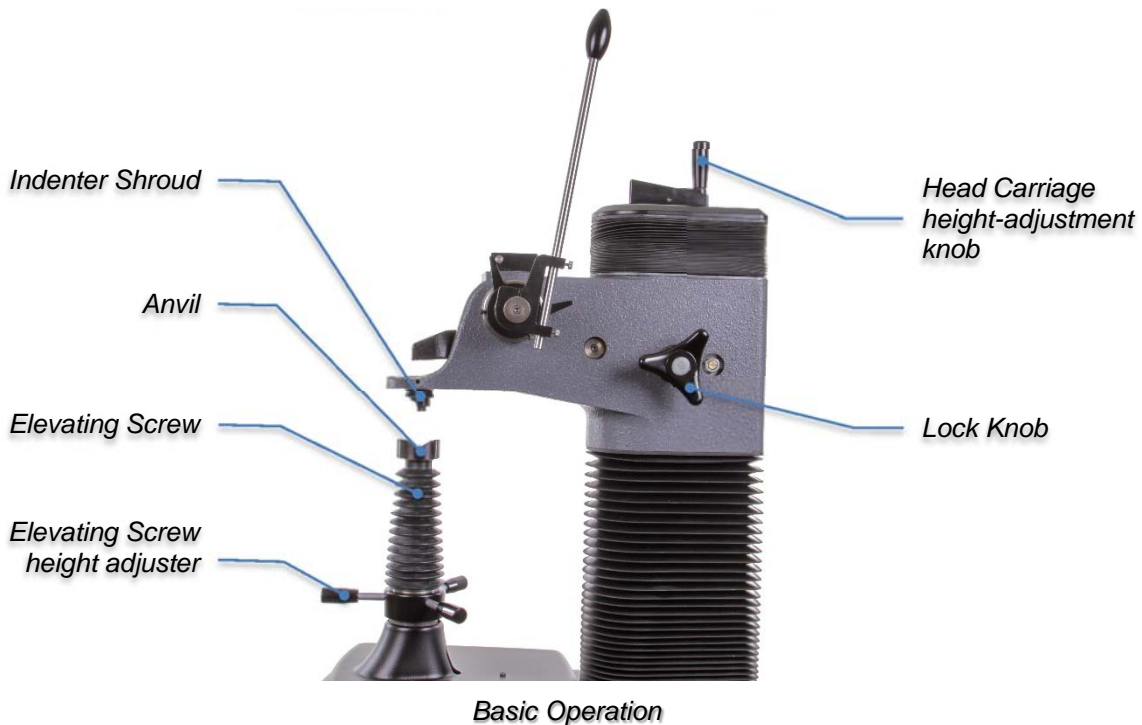

5.3 All Manual or Automatic Bench Stands

Your tester should be installed before proceeding and the test head set up for operation with a diamond indenter in place (See Section 3.0)

1. Check to make sure a diamond indenter is installed in the test head. If not, refer to the next section for installing indenters. **BE SURE THE INDENTER SHROUD IS INSTALLED.**
2. Put the two inch flat anvil in the elevating screw and place a Rockwell C test block on the anvil (Or Rockwell N block if using a superficial head).
3. Raise the elevating screw by turning the height adjuster until the test specimen touches the clamping shield (if the clamping shield is being used) or until it is within 1/16" of the indenter (the test piece should not touch the indenter). If the elevating screw will not raise high enough when using a BT130T stand, loosen the lock knob at the right rear of the stand and turn the height adjustment knob at the top-back of the stand to lower the test head position.
4. Turn the power switch on at the back of the test head. The display will initiate with the "Splash Screen".
5. After the "Splash Screen" flashes the Ametek and Newage logos, the display changes to show the "Test Screen".
6. For manually operated testers, pull the load lever forward until it stops. Hold the lever down until time reaches zero, then release to remove the load.



Manual Operation

7. For automatic machines simply press the remote foot pedal. The display will show the Rockwell test value.



Automatic Operation

This is the complete test cycle. The operator is now ready to make another test. Proceed to the sections describing changing scales, changing indenters and other procedures and operations.

5.4 Changing Scales

When changing scales, the indenter and the load selection both need to match the selected scale. After changing scales a mechanical load lock feature must be implemented as a secondary measure to avoid using the machine with a load outside the specification and obtaining erratic readings.

The Versitron loading mechanism is totally contained within the testing head. Inside is a precision elastic member which has been exercised many times prior to assembly. The exercising gives its “set” position so there is no major deviation during its life. The slight movement required to apply the full load assures consistent and accurate Rockwell measurements. Minor calibration adjustments inherent with all Rockwell testers can be achieved very easily with this system. The preload is preset inside the test head: 3 kg for Rockwell superficial heads, 10 kg for regular Rockwell heads.

Regular Rockwell Heads	Superficial Rockwell Heads	2DS Systems
HRC	HR15N	HRC, HR15N
HRB	HR30N	HRB, HR30N
HRA	HR45N	HRA, HR45N
HRE	HR15T	HRE, HR15T
HRF	HR30T	HRF, HR30T
HRD	HR45T	HRD, HR45T
HRG	HR15W	HRG, HR15W
HRH	HR30W	HRH, HR30W
HRK	HR45W	HRK, HR45W
HRL	HR15X	HRL, HR15X
HRM	HR30X	HRM, HR30X
HRP	HR45X	HRP, HR45X

Test Head Scales

5.5 Changing The Hardness Scale displayed

The Hardness Scale displayed can be changed from the **Setup** screen, when the Hardness Scale option is selected, a drop down list is shown with the appropriate scales for the measurement head.

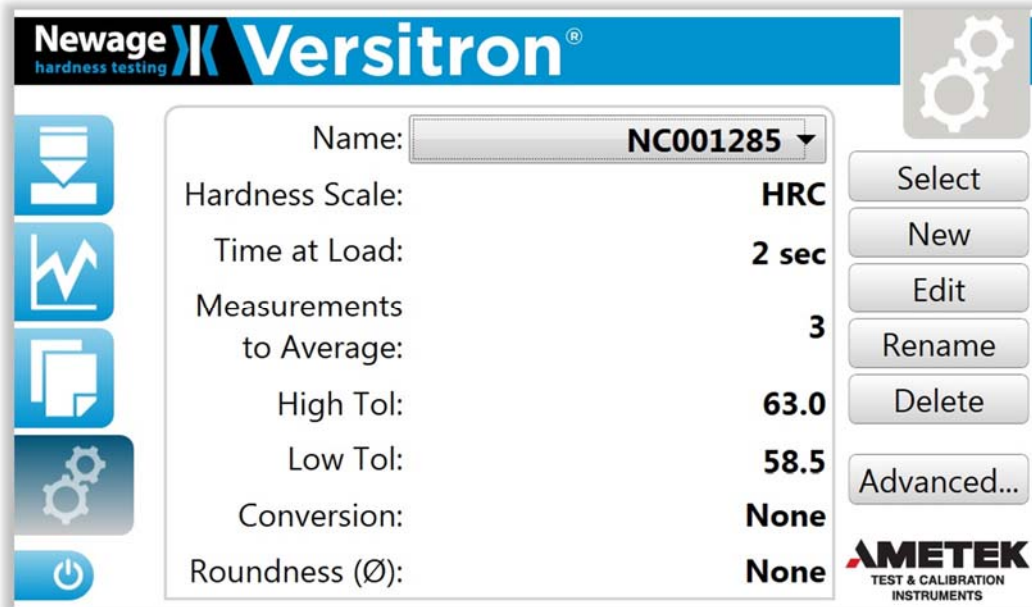

After selecting a new scale option, the user is prompted with the Indenter installation screen. A complete procedure on how to change the indenter is explained in further detail in section 5.6. When the Installation of the new indenter is complete, hit "Next" to go to the Capstan adjustment, (see section 5.7).

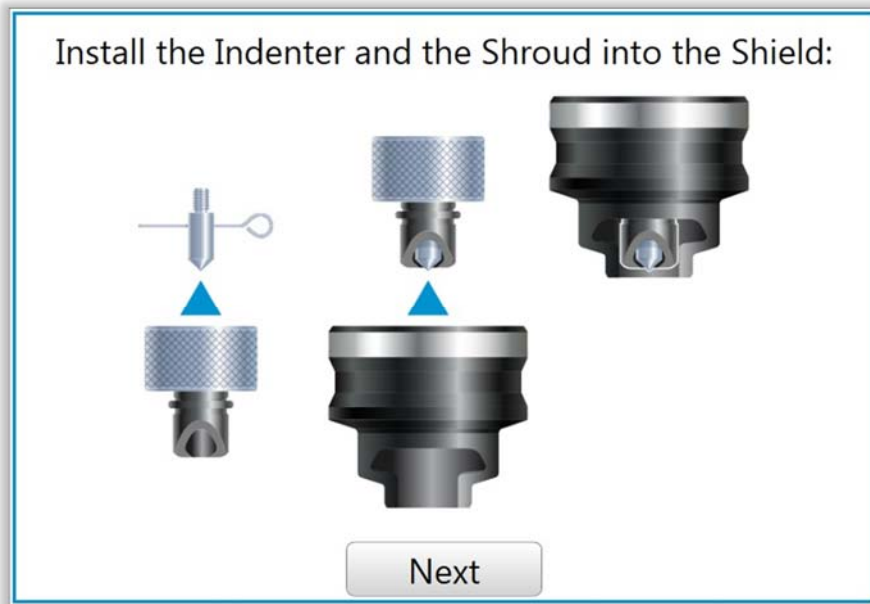

5.6 Changing Indenters



NOTE: THE INDENTER SHROUD MUST BE SECURELY IN PLACE WHEN TESTING.

The indenter area on your Versitron is different than most testers. An indenter shroud surrounds the indenter to act as a holding device for parts under load and to reference the surface position of the test specimen. It also acts to protect the diamond to an extent. Clamping shields may also be used to hold parts that hang off the edge of the anvil. The clamping shield surrounds the indenter shroud. The following procedure is to be used to change the indenter.

1. Remove the clamping shield, if it is installed.
2. Unscrew the indenter shroud. This is done by turning the knurled nut clockwise until it comes loose.
3. Remove the indenter using the pin wrench provided in the accessory case. Insert the pin wrench into the hole or the side of the indenter and unthread to loosen and remove. Take care not to remove or damage the indenter probe that drops down when the indenter is removed. Do not use pliers and avoid damaging the indenter holder area.



Changing Indenter

4. Choose the correct indenter from Rockwell Scale Table II, Reference Section 8.I. Testers are provided with 1/16" ball indenter and diamond indenter.
5. Make sure the thread, the concave end, and the shoulder of the indenter are clean.
6. Screw in the indenter and make snug with pin wrench.
7. Check to verify that the wavy washer is inside the indenter shroud. Screw on the indenter shroud with cut-away portion facing front (if a cutaway indenter shroud is used). Be sure to screw in until finger tight. Check that the indenter shroud contact points are smooth and clean.

8. The shroud and indenter area should be kept free of dirt and grease which could hamper operation.



NOTE: Calibration on ball indenter scales is directly related to length of the indenter. When replacement ball indenters are required the purchase order should reference the serial number of the test head (located on chrome capstan wheel). Also note: Balls in the ball indenters can be deformed on harder surfaces. They are easily replaced by unscrewing the indenter cap and replacing the ball.

The system will prompt the user with a verification screen, to change the Indenter. When the installation is complete click “Next” to continue with the capstan adjustment for load selection.

The first test after changing balls must be discounted since it seats the ball in the indenter.

5.7 Changing & Adjusting Load

If the hardness scale has been changed and the load settings needs to be adjusted, the Adjust Load screen will guide the user to make the physical adjustments to set the machine to the proper load position. When the user adjusts the load setting, they turn the Capstan Wheel until they are at proper load position (within tolerance). This screen will prompt the user to turn the wheel to the left or right to adjust the load up or down, giving a range indication when they are getting close to the target value and when they are within the allowable range. The adjustment becomes more sensitive near the target.

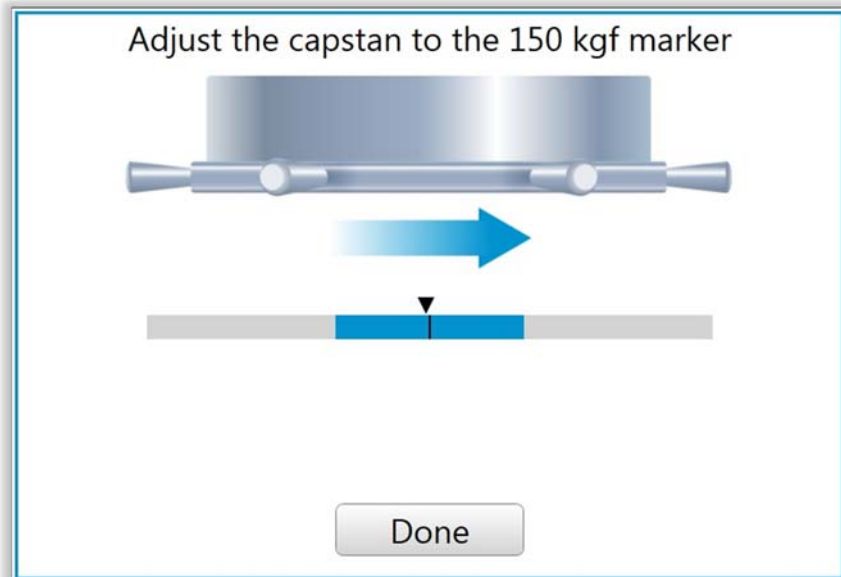

As previously indicated the load setting is changed by turning the chromed Capstan Wheel on the test head. As an approximate to the capstan wheel adjustment screen, a red line indicator on the load plate moves from one load position to another as the wheel is turned - for example from 150 kg to 100 kg on a regular Rockwell scale head or from 45 kg to 30 kg on a superficial Rockwell scale head. The red line indicator should be approximately centered at the proper load setting hole on the load plate. Then the operator should check the calibration. (see section 5.9).

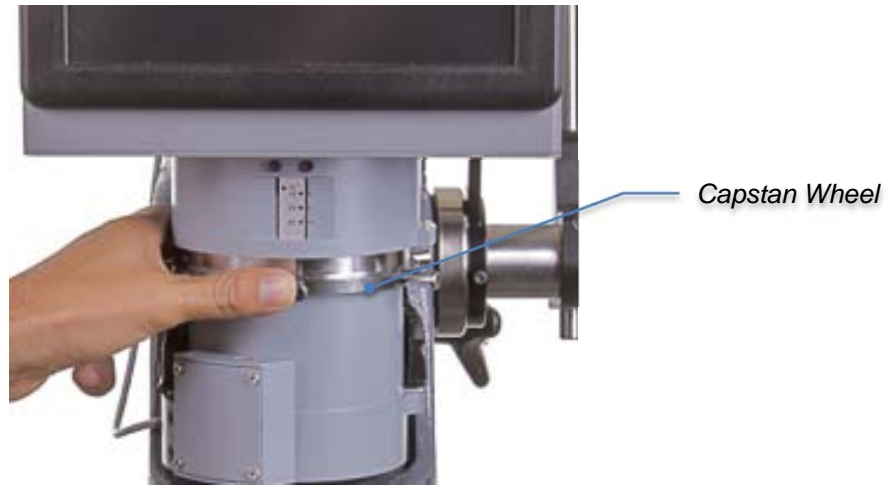

Changing Load

To determine the proper load for a given scale, refer to the chart at the back of the manual (section 9.1).

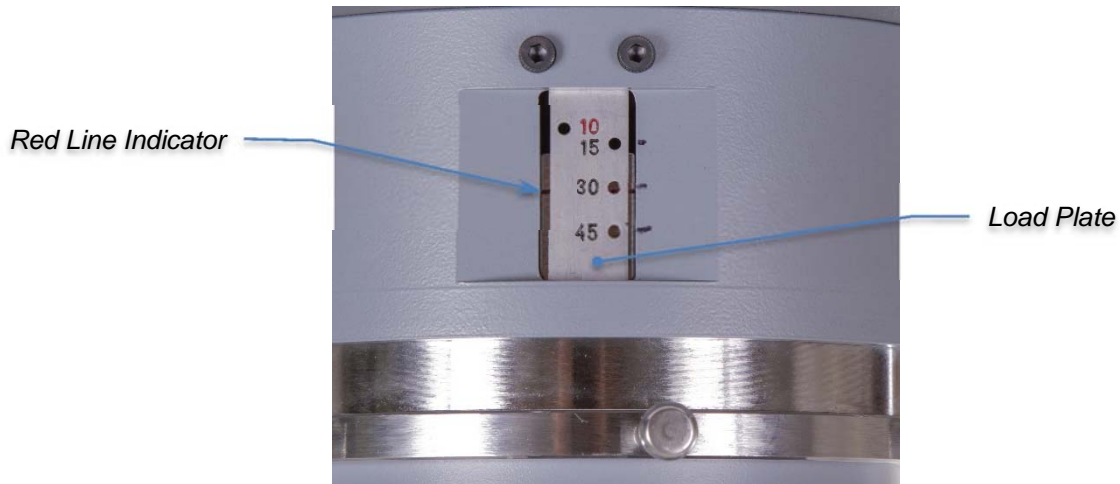

Adjusting Load

After changing scale, it is recommended that a test block is used to verify the accuracy of the machine. Following the selection of a configuration and subsequent load adjustment, the machine will default to Verification Mode. While in verification mode and to keep verification measurements out of the test data, measurements will not be stored in your data file, will not be included in the statistics nor will be send to DataView. The machine can be manually be put into Verification Mode via the Advanced Settings screen (see section 5.25). When finished hit Done to exit Verification Mode.

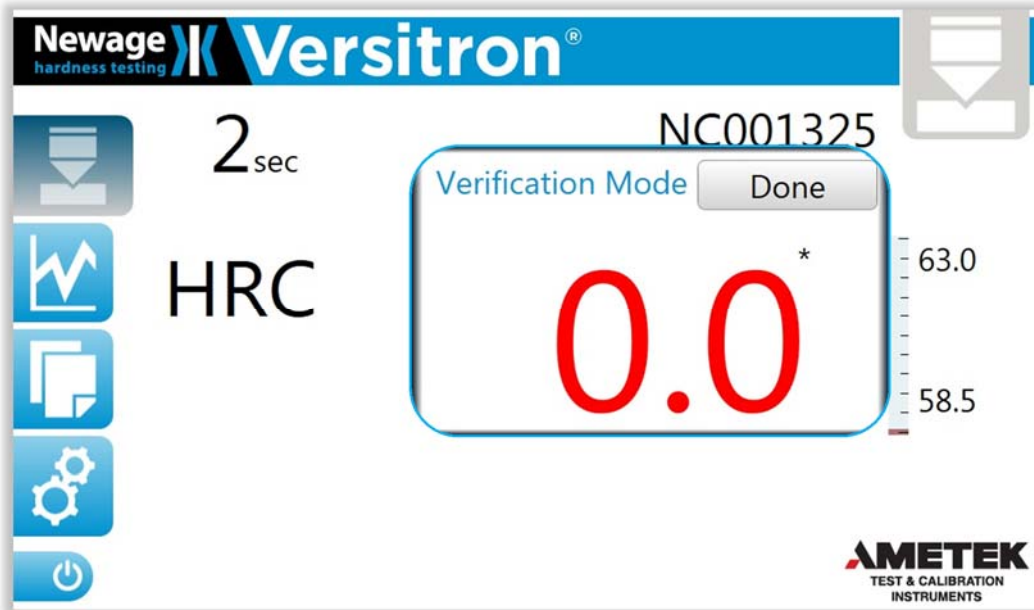

5.8 Load Lock

As a preventive measure, a load lock feature is provided. This mechanical option prevents the operator from using the machine with a load outside the predetermined specification. Once the load setting and adjustment has been completed, secure the Calibration Lock to the head upper shell notch.

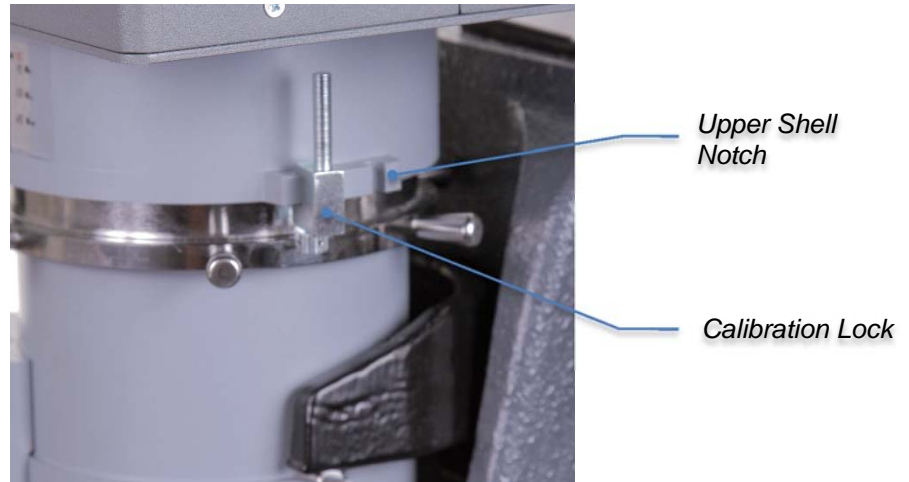

Load Lock Setting

Also, in the event that a test would be taken with the load outside the specification, an error message will appear on the display.

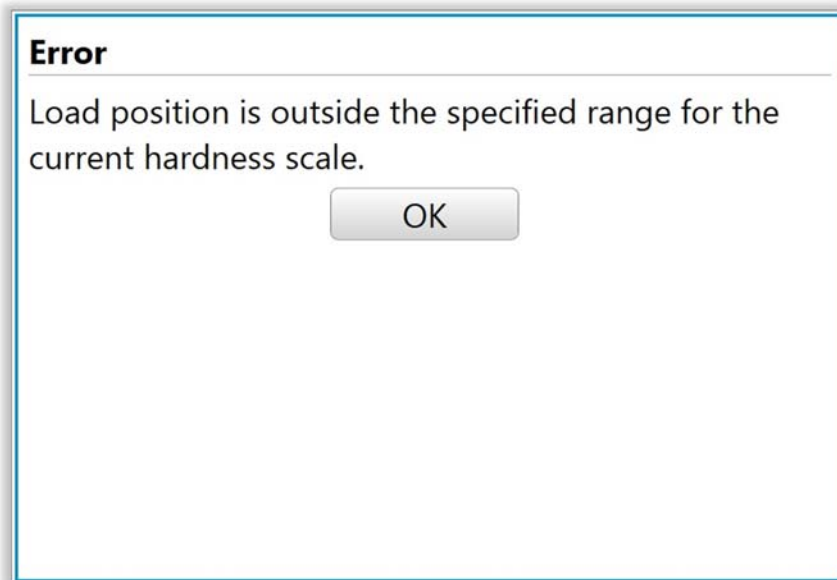

5.9 Clamping Shield Operation: Large Parts

The use of the clamping shield is optional. When performing calibration and testing on small parts, it is advisable to remove the clamping shield.

The clamping shield is useful to eliminate fixturing of large parts that overhang the anvil. Unlike other Rockwell scale systems, external supports and leveling fixtures are not needed.

A second important use is to protect the indenter from impact and costly damage from test specimens when the specimens are placed on the anvil. Also, clamped parts will not shift under load which can break diamond indenters.

1. Snap or press in the clamping shield onto the stand around the indenter and indenter shroud. Be sure the cut out portion of the bottom of the clamping shield faces front (if there is a cutout section) The proper fit of the clamping shield into the stand can be adjusted with the tension adjusting screw to maintain proper tension for the clamping shield so it will stay in place while not being too tight to remove. Adjust according to need.
2. Clamp the part firmly between the shield and anvil by raising the elevating screw until the part is tightly fixed.
3. The part can now be tested like any other part.
4. Remove the part by dropping the elevating screw.

5.10 Checking Vee Anvil Alignment (for Testing Rounds)

When round parts have to be tested, the alignment of the indenter tip with the specimen has to be nearly perfect.

1. Securely tighten the height locking knob on the head carriage.
2. Tighten (only by hand) the anvil plate knob.
3. Insert small Vee anvil.
4. Place a small cylindrical specimen (about 1/8" diameter) on the anvil.
5. Bring the specimen close to the diamond indenter without making contact.
6. Check the alignment in two positions, rotating the anvil 90 degrees each time. The tip of the diamond must line up precisely with center of the specimen.

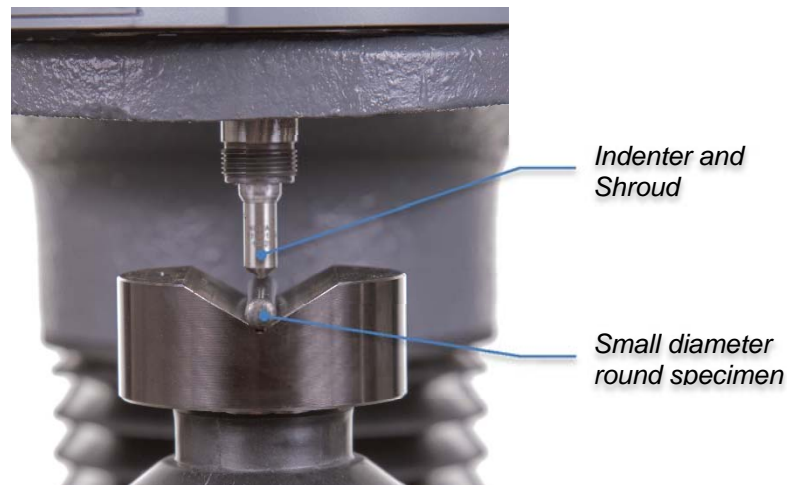

Checking V-Anvil alignment

5.11 T-Stand; Vee Anvil Adjustment

If the Vee anvil alignment is not correct:

1. To correct the left-right alignment, find the locking nuts on the sides that hold the back column.
2. Loosen the locking nuts, slightly turn the set screws to adjust the centering and then tighten the locking nuts. Note that the set screws should barely touch the column and should not apply pressure on them. After locking the nuts, check for free up-and-down travel of the head carriage by turning the height adjustment knob; you may need to use the lock knob. Do not touch the two screws on back of the columns.

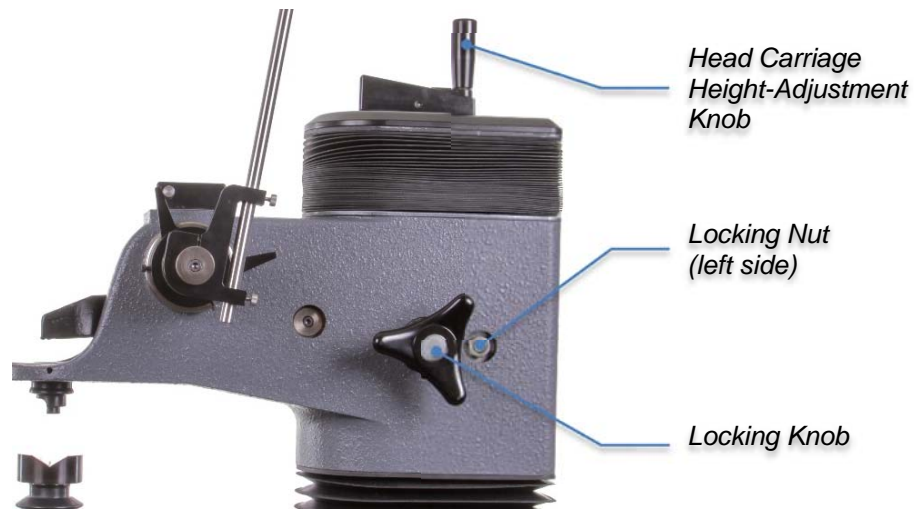

T-Stand Vee Anvil adjustment: side-to-side

3. Front-to-Back centering is adjusted by the set screw and nut underneath the anvil stage.

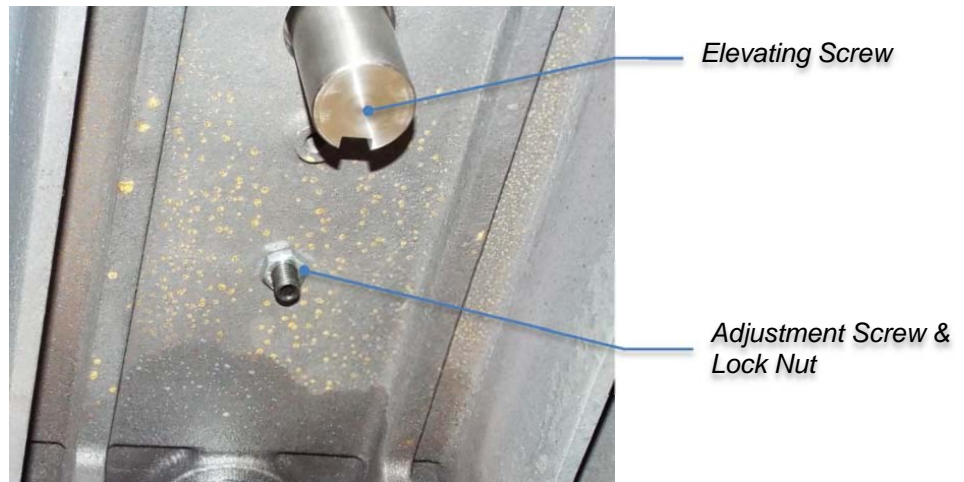

*T-Stand Vee Anvil adjustment: front-to-back
(underside view)*

4. Loosen anvil plate knob.
5. Slide the stand forward on bench until the elevating screw is slightly over the edge to work on screw and nut located on the underside of anvil plate. (Be careful not to allow tester to tip over.)
6. Loosen the locking nut.
7. Turn screw up (clockwise) to move the anvil forward, down to move the anvil back.
8. Check alignment again after tightening the locking nut and anvil plate knob. Do not use excessive force.

An alternate alignment method is to tighten or loosen anvil plate knob using the special wrench provided. This permits minor small Vee anvil adjustments to be made quickly.

5.12 N-Stand; Vee Anvil Adjustment

1. Slide front of stand over the edge of the work table. Be careful not to allow the tester to tip over.
2. If alignment is out, adjustment is performed by loosening three [3] set screws under the elevating screw on the underside of the stand. A large ring holds the adjustment position when secured by three screws.

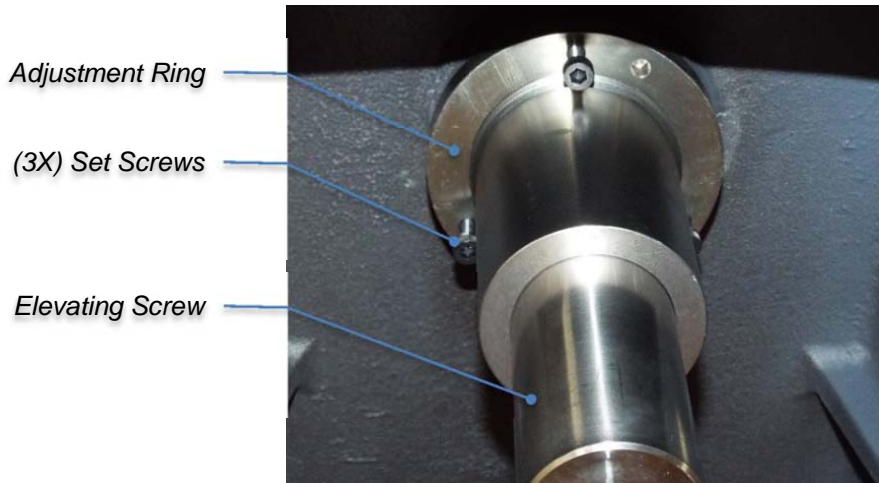

*N-Stand Vee Anvil adjustment
(underside view)*

3. Loosen three screws slightly to allow movement for centering.
4. Adjust elevating screw to proper Vee anvil alignment at each 90 degree rotation of the anvil.
5. Then tighten set screws
6. Recheck after fully secured

5.13 Indenter Shroud, Clamping Shield Options

Additional components can be used for testing in narrow confined areas or tight locations. (See “Options & Accessories”). Optional indenter extensions and longer indenter shrouds with or without longer clamping shields are often used. The indenter is threaded on at the extension and the extension is tightened into place followed by the extended shroud. (Refer to section 4.6 for changing indenters).

5.14 Testing Tapered Parts – Ball Swivel Anvil (Option)

Insert the ball swivel anvil into the elevating screw. Install the clamping shield. Loosen the locking ring that holds the ball in place. Place tapered part on the flat spot on the ball swivel and roughly orient it so that the top surface of the tapered part is roughly level. Raise the elevating screw until the top tapered surface is clamped level. The ball swivel locking ring may be tightened, if desired, for a series of tests on similar parts. Perform the test as any other part is tested. Lower elevating screw. The ball swivel is properly positioned for testing another part with identical orientation. (Refer to “Options & Accessories”).

5.15 Testing Without Anvil Stage, BT130T Stands

The anvil stage with elevating screw may be removed to increase the test stand capacity to its maximum.

1. Snap in clamping shield to protect indenter.
2. Lower anvil about 2" (5 cm) from indenter.
3. Loosen anvil plate screw. If necessary, use a spanner wrench in kit

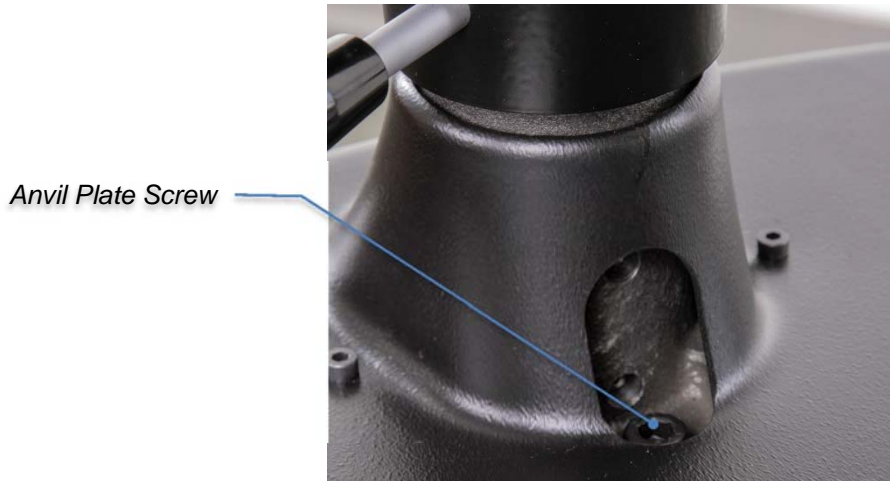

4. Grip the anvil stage with both hands and lift up and out diagonally.
5. The tester base can be used directly as an anvil to support large test pieces. This test base can also be used to support fixtures for testing irregularly shaped parts.

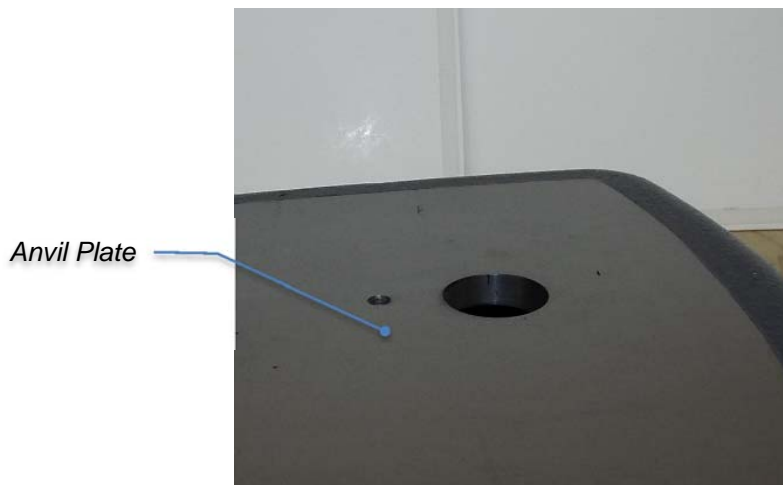

6. On large work pieces, use the clamping shield to secure parts. Otherwise, maintain a distance between indenter and work piece at approximately 1/16". Maximum vertical capacity without anvil stage is 16-1/2" (420 mm) (standard unit). Maximum horizontal reach is 8-1/2" (215 mm). Other T-stand vertical capacities are available up to 36". Use the clamping shield on larger openings to reduce excessive deflection.
7. When replacing anvil stage, be sure the test plate and bottom supports of the stage are clean. Then reverse procedures and hand-tighten anvil plate screw. Do not use the wrench for tightening.

Conditions Necessary for Reliable Test Results

Test load must be properly set.

Indenter and its shroud must be properly screwed in. The indenter must correspond with test load for appropriate Rockwell scale (see Section 8.1).

Clamping Shield should be snapped in place when testing large parts or removed for testing small parts.

Distance between indenter and test piece should be set at 1/32" to 1/16" clearance without clamping shield in place; or with clamping shield in place, part should be clamped tight.

Operating lever (on non-automatic models) should rest in vertical position at beginning of test cycle.

Readout set to proper scale corresponding to load and indenter.

5.16 User Interface (UI) Control Unit

Before proceeding the operator should be familiar with the basic test operation and scale changing. See previous sections for directions on these functions.

5.17 Installation

For proper installation instructions of the U.I. Control Unit, refer to section 3.5 of the manual.

5.18 Powering Up

Power up the Control Unit from the power switch located on the back of the console. When the Control Unit is powered up, the initial “splash screen” first flash the Ametek logo, followed by the Newage hardness testing logo, along with the firmware version and the machine serial number.



5.19 Basic Operation

The Versitron U.I. consists of a column of function tabs on the left side of the screen that are used to navigate to the main portions: **Test Screen**, **Statistics Screen**, **Files Screen** and **Setup Screen**. The **Power** tab option at the bottom closes and shuts down the machine.

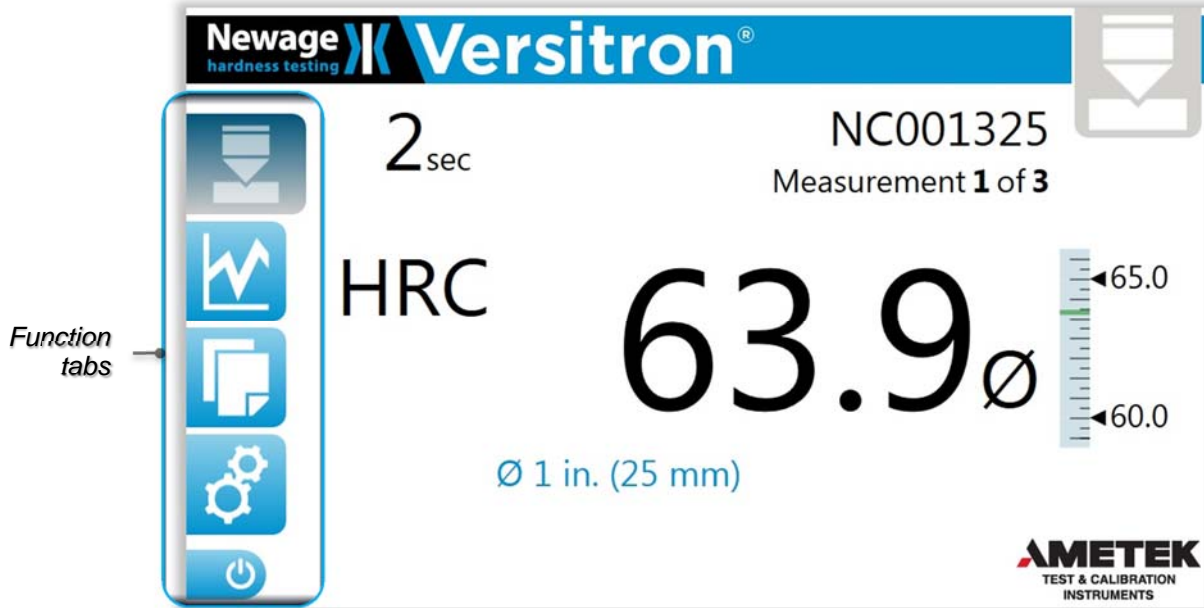

Certain screens require either a "Supervisor" or "Technician" password to access the screen. In those cases, a keypad login dialogue screen is presented before the requested screen. The requested screen is only presented after a successful password entry.

5.20 Test Screen

 The **Test Screen** displays after the “splash” screen and is the primary measurement screen for the Versitron. When a hardness measurement is performed, both the hardness scale and hardness reading are displayed on this screen. If tolerances have been established; a tolerance limit range indicator will be displayed also.

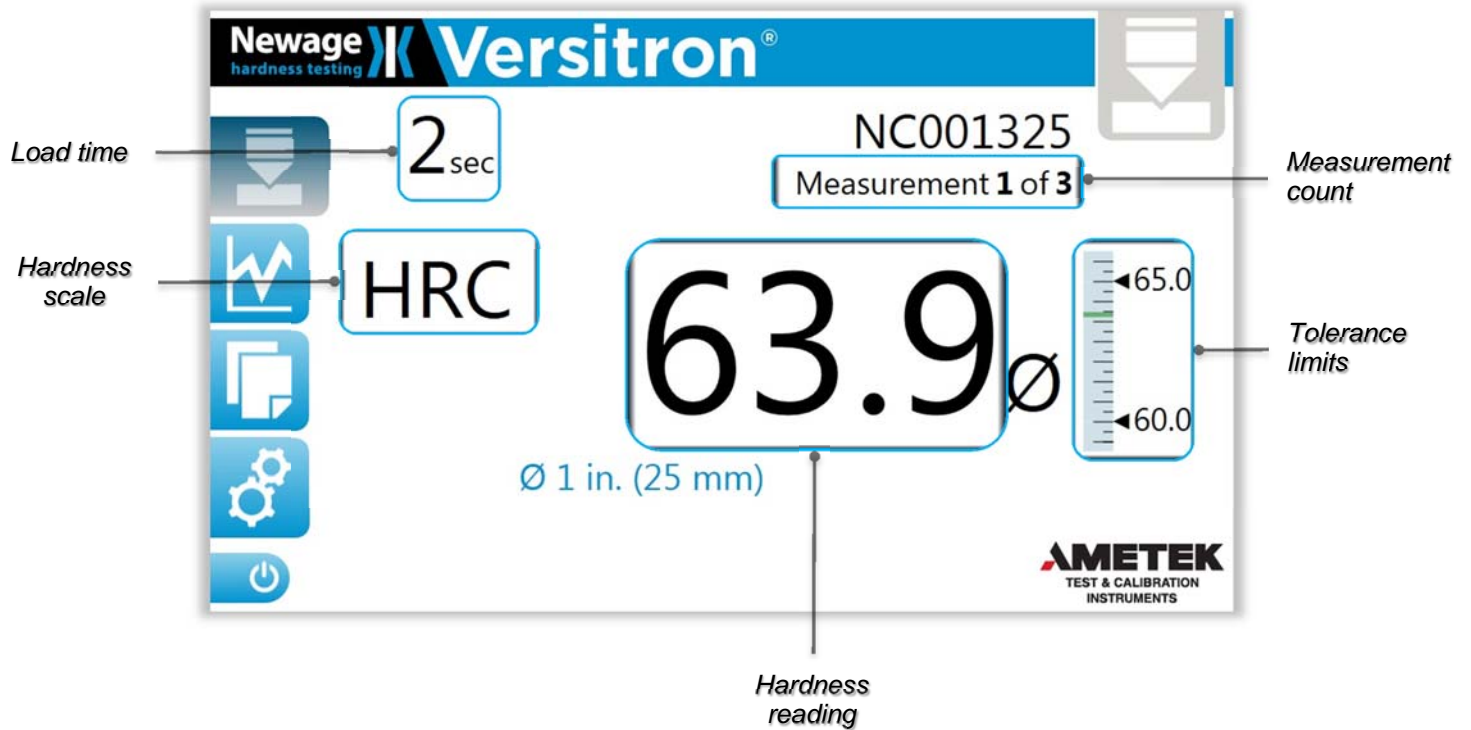

5.21 Statistics Screen

 The Statistics screen displays basic statistics from a current part. All of the measurements must be made using the same scale. The displayed statistics are: **Count**, **Average**, **Std. Deviation**, **Max** and **Min**. If **High** and/or **Low Tolerances** are entered, the number (up to 100) of “**Pass**” measurements and “**Fail**” measurements is displayed. A list of measurement values for the current part are displayed, along with a button to **Delete Last** measurement.

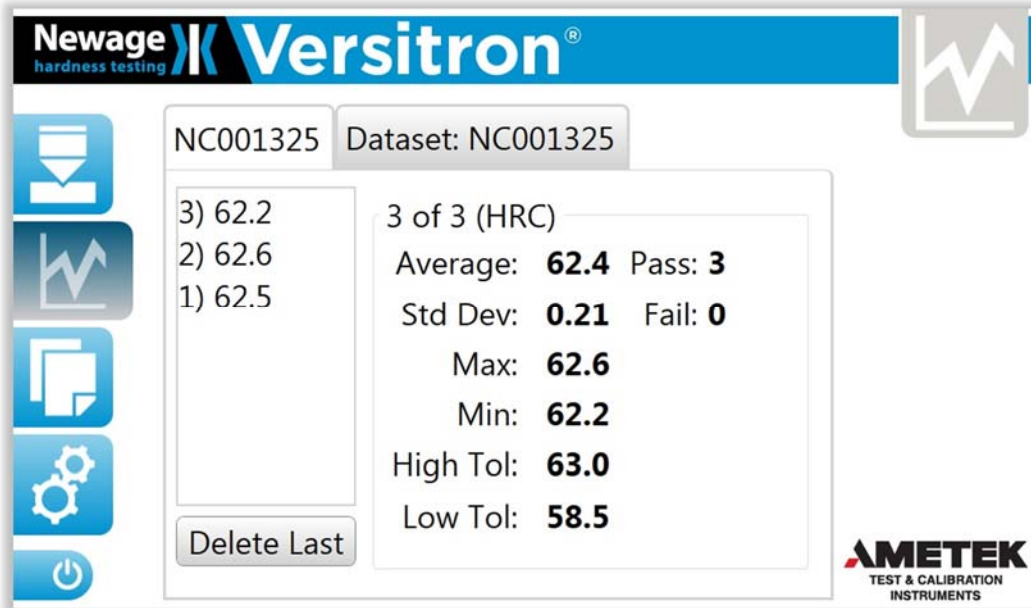

In the event that a measurement is taken by error i.e. a measurement performed on an existing whole, the reading will be displayed in highlighted red.

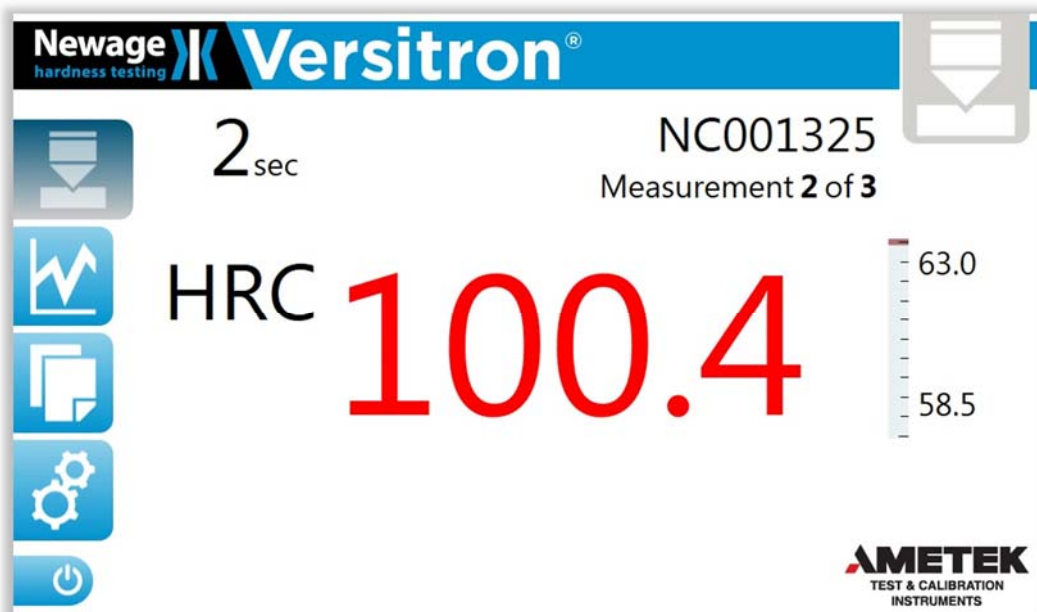

When the erroneous measurement needs to be removed, go to the **Statistics Screen** and select the **Delete Last** button.

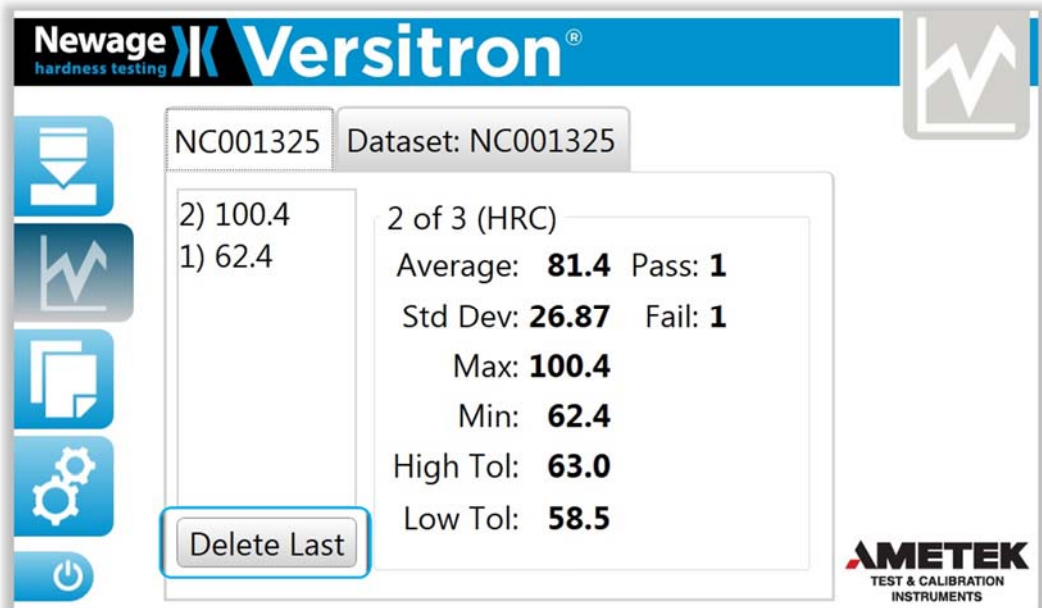

The measurement will be removed and all statistics recalculated.

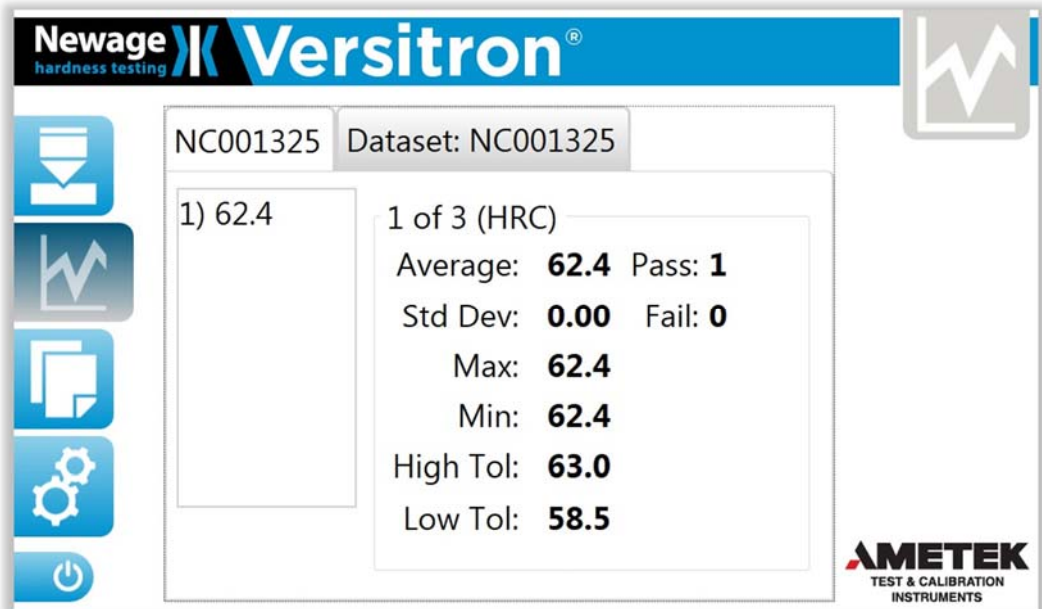

To see the statistics for the entire set of parts click the **Dataset** tab. If the statistics for a batch of parts for which multiple measurements were made are being displayed, the “pooled” **Average** and **Standard Deviation** for the measurements is presented, along with the overall **Max** and **Min**, the **High** and **Low Tolerance**, the number of measured **Parts**, the number of **Pass/Fail** measurements and the history of the **Averages**.

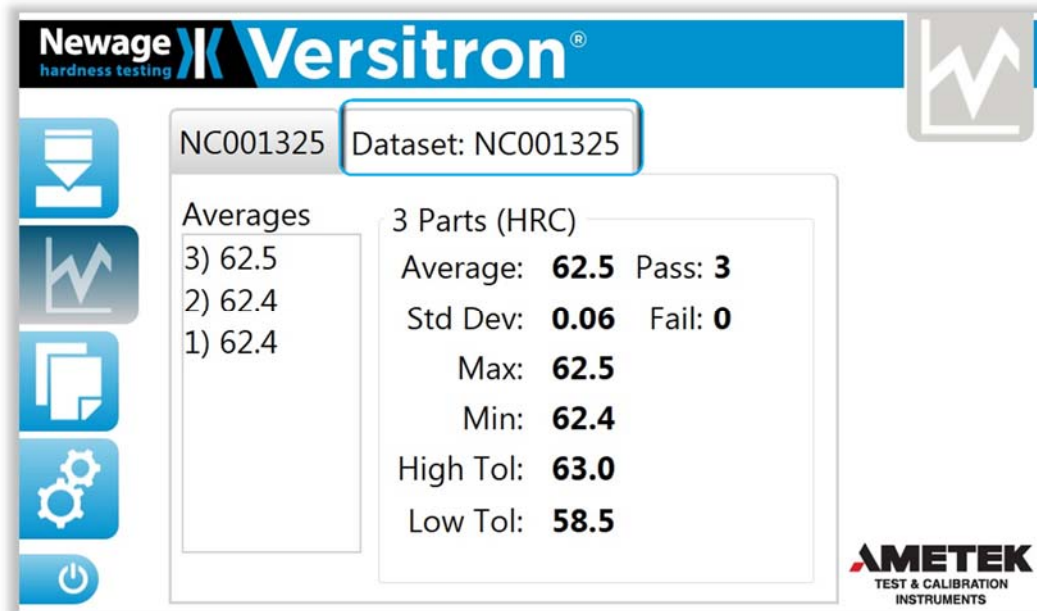

5.22 File Screen



The **File Screen** allows stored files on the machine's computer to be copied to an external USB drive. The USB drive must be plugged into the USB A connector at the bottom of the console (it must be inserted after start-up, as the USB is the default boot drive and if present the application will not load). The File screen also allows an existing file to be opened, so new measurement data can be added to that file. The **File Screen** allows the user to **Clear Data**. The Clear Data function will require a supervisor login. The user is also able to turn logging to *DataView* On or Off. (*DataView* is an off-line data analysis package, sold by Newage for use with the Versitron). When logging to *DataView* is enabled, all measurements are sent via serial communication to an external computer running *DataView* (details of this communication are explained in a separate section). This connection is made via the USB B connector on the back of the console. A driver for the USB device is shipped along with the machine and must be installed prior to launching *DataView*. The **File Screen** also provides an indication of **Disk Usage** (as % of capacity).

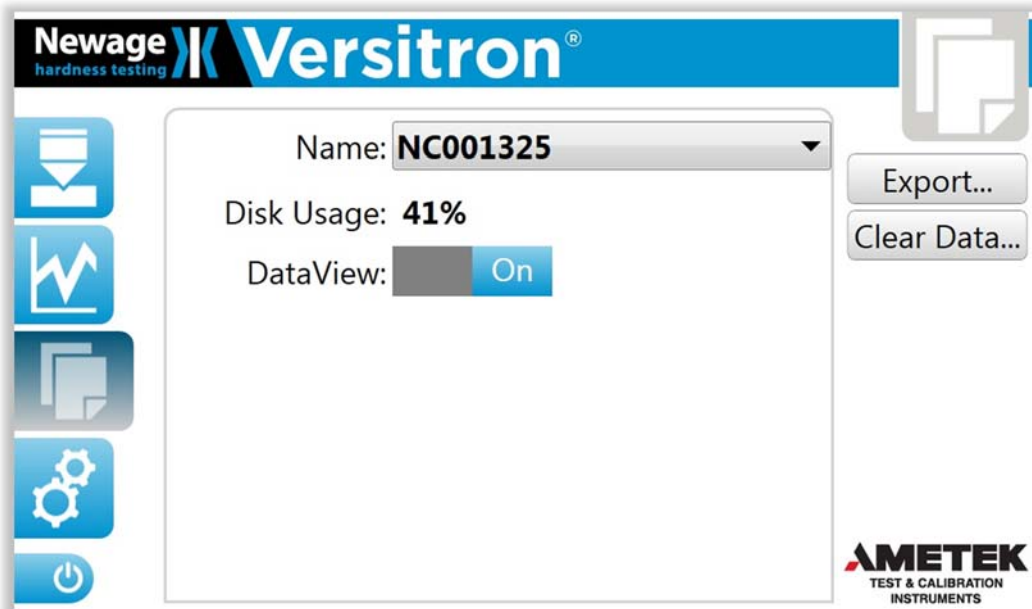

To export data, select the data set from the drop down list and hit **Export**.

The function will be confirmed by an Export complete prompt screen, hit **OK** to continue.

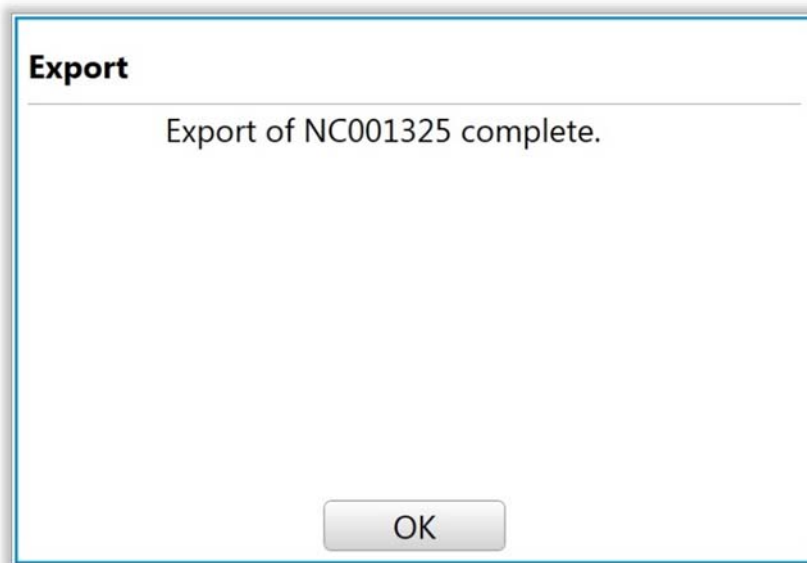

5.23 Setup Screen



The **Setup Screen** provides access to the functions required for selecting test parameters. Many of these parameters are optional. The test machine should always start up ready to test using the most recently set configuration (if applicable). From the **Setup Screen**, the user is allowed to enter a **New** configuration test, **Select**, **Edit**, **Rename** or **Delete** an existing configuration. The **Advanced** button allows the user to access further functions and settings.

The screenshot shows the Versitron Setup Screen with the following configuration:

Parameter	Value
Name	NC001285
Hardness Scale	HRC
Time at Load	2 sec
Measurements to Average	3
High Tol	63.0
Low Tol	58.5
Conversion	None
Roundness (Ø)	None

Buttons on the right: Select, New, Edit, Rename, Delete, Advanced... AMETEK TEST & CALIBRATION INSTRUMENTS logo is at the bottom right.

Selecting **New**, allows the user to set the file **Name**, **Hardness Scale**, **Time at Load**, **High** and/or **Low Tolerance**, **Scale Conversion** and **Roundness** correction, for their test configuration.

The screenshot shows the Versitron Setup Screen with the following configuration:

Parameter	Value
Name	NewConfig
Hardness Scale	HRC
Time at Load	2 sec
Measurements to Average	3
High Tol	None
Low Tol	None
Conversion	None
Roundness (Ø)	None

Buttons on the right: Save, Cancel. AMETEK TEST & CALIBRATION INSTRUMENTS logo is at the bottom right.

a. Hardness Scale

The **Hardness Scale** selection defaults to the current setting, with a drop down list to select a different scale. The drop down list will only show the hardness scales appropriate for the installed measurement hardware (Regular Rockwell or Superficial.) If the **Hardness Scale** is changed, a series of screens will walk the user through the required physical changes to the machine.

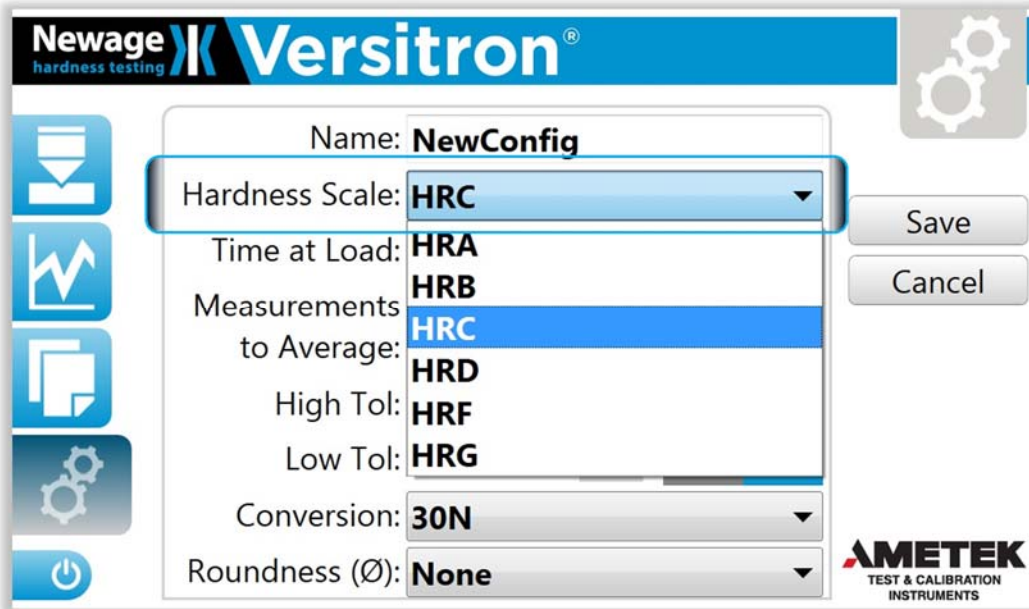

b. Time at Load

The **Time at Load** defaults to the current setting, with plus “+” and minus “-” icons to adjust the time in 0.1 sec. intervals from 2 seconds up to 90 seconds.

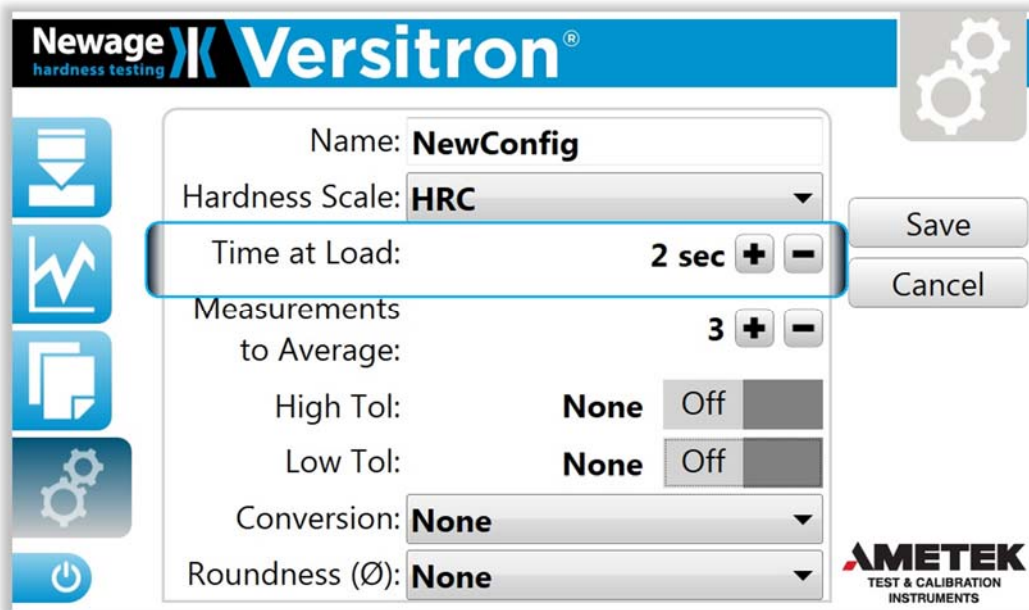

c. Measurements to Average

This function allows the user to set the number of test measurements to average per individual specimen, with plus “+” and minus “-” icons to adjust the count from 1 to 100 measurements. When multiple measurements are selected, an average will be displayed following the final measurement.

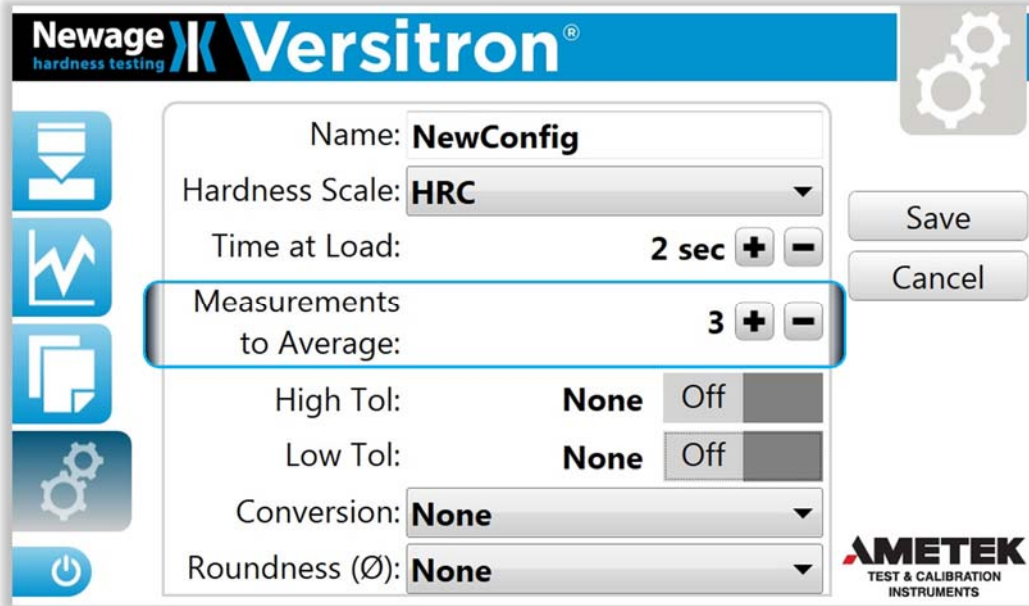

d. High Tol & Low Tol

The “High Tol” and “Low Tol” selection is made via a “hot field” or “On” button that prompts the number entry keypad which includes a “decimal point” and “back” key. It will prompt the user to enter the **High** (or **Low**) Tolerance and select “Enter” to accept.

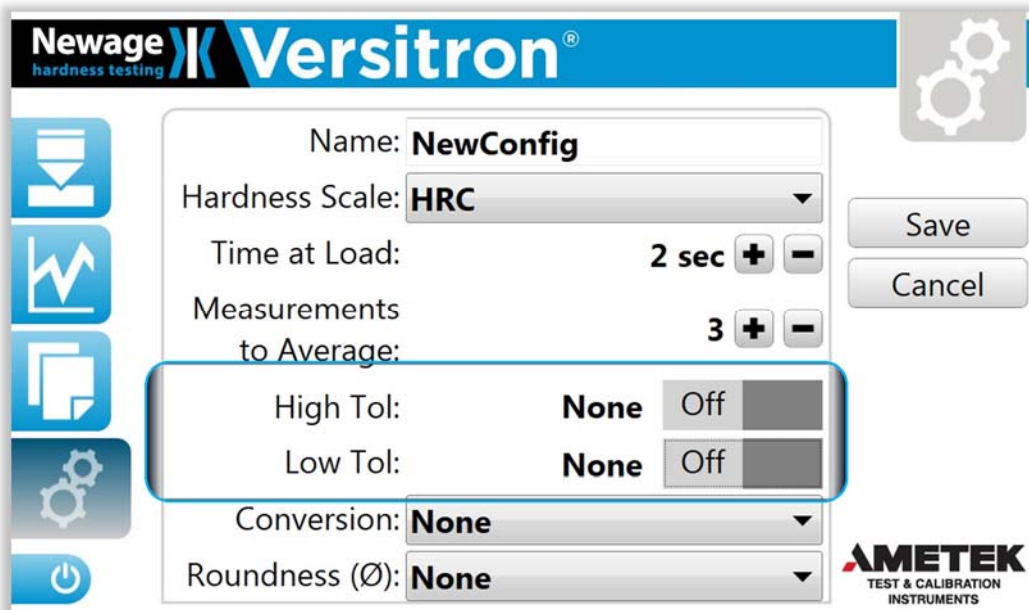

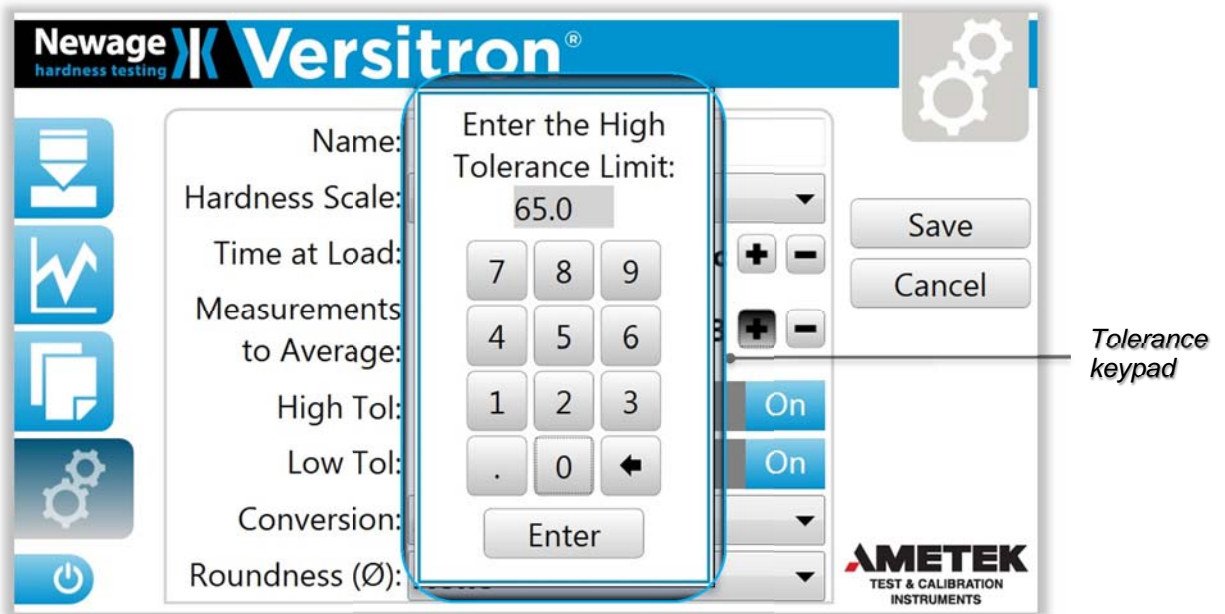

e. Conversion

The **Conversion** selection is made with a drop down list of scales appropriate to the selected **Hardness Scale** only (see ASTM E18-14, pg. 25-27).

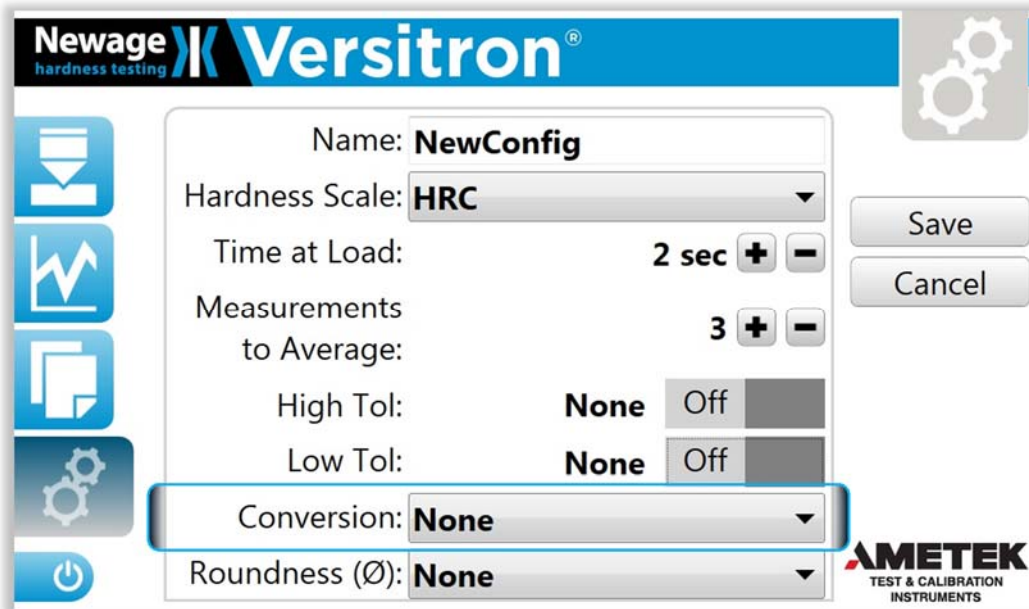

f. **Roundness (∅)**

The **Roundness (∅)** selection defaults to the current setting with a drop down list to allow selection in 1/8" increments (listing associated mm measurement) from 1/4" to either 1" or 1 1/2" as appropriate for the selected hardness scale (see ASTM E18-14, pg. 30).

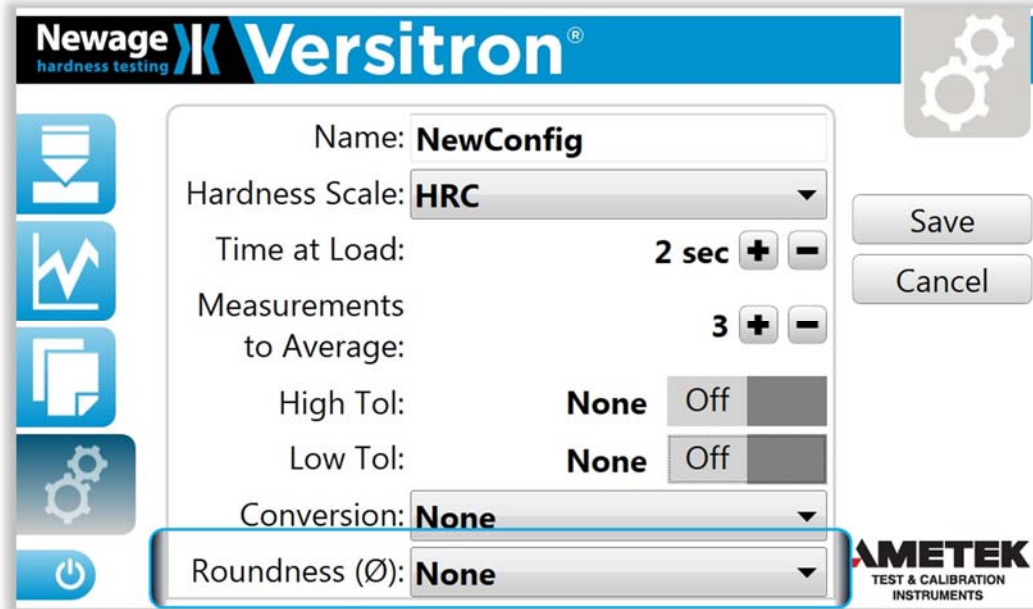

A roundness icon and roundness correction will display on the **Test Screen** reading when this function is enabled.

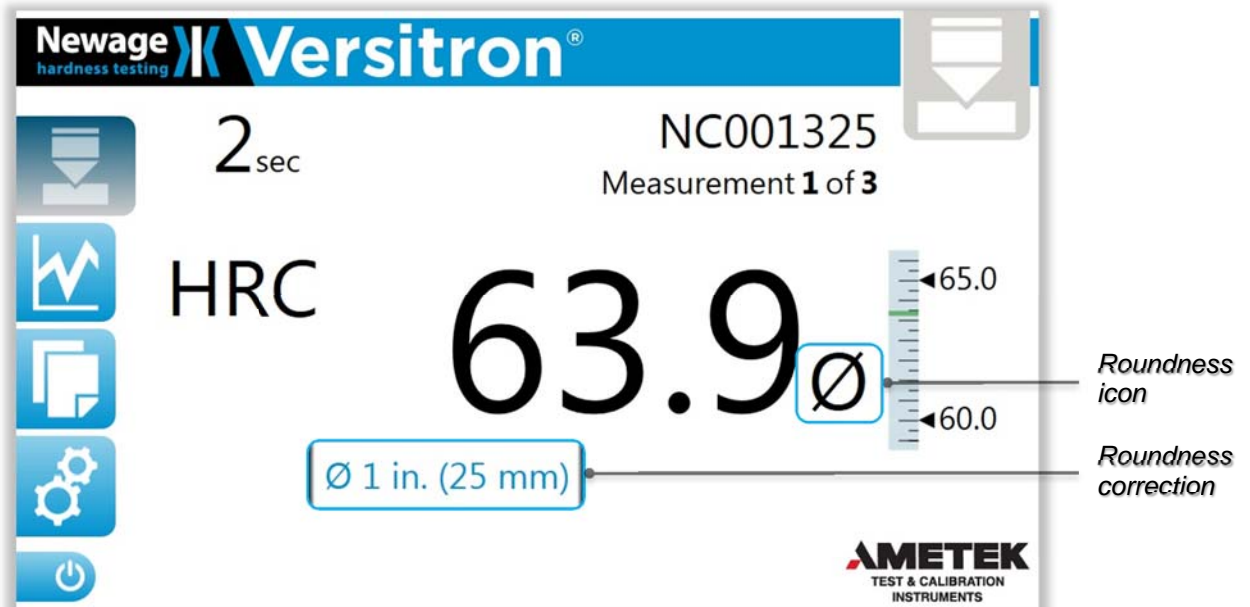

5.24 Advanced Settings

Selecting the **Advanced** function, prompts the **Advanced Settings** screen which allows the user to enable **Minimum Thickness**, **Verification Mode**, **Set Date & Time**, view machine specific information and access the **Technician** screen.

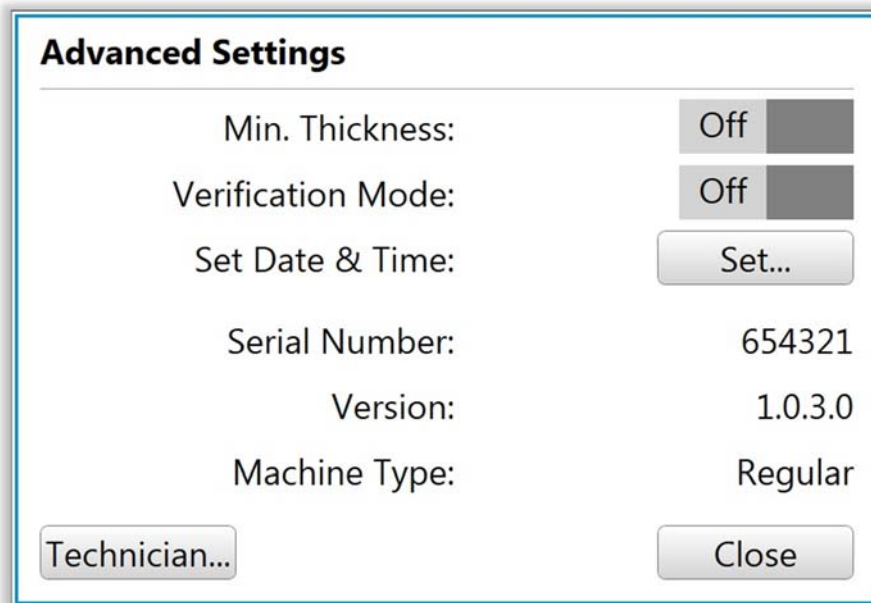
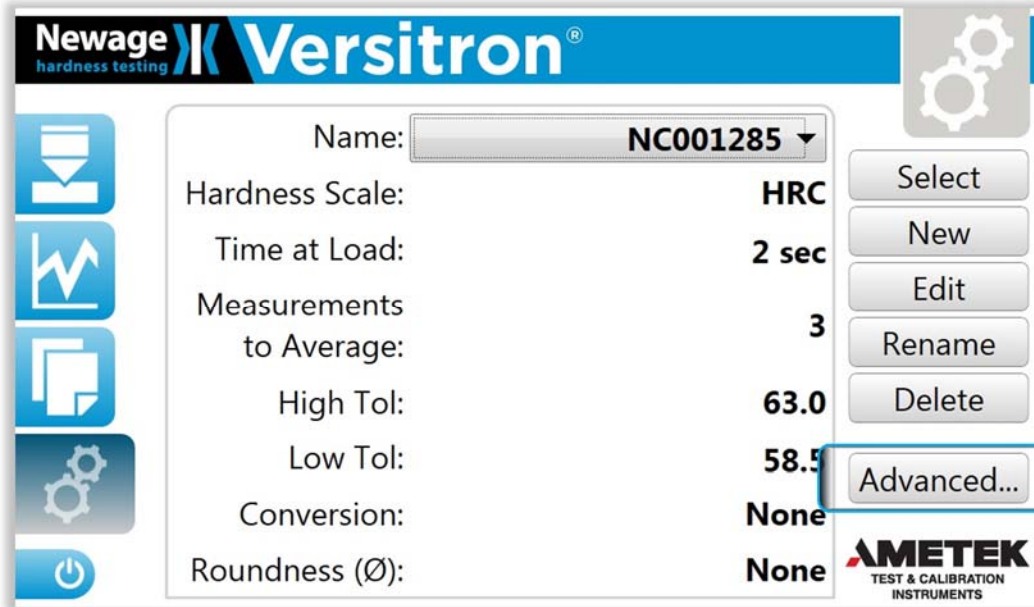

The **Minimum Thickness** function is On/Off selectable. When enabled, it uses the minimum thickness value for a corresponding hardness in the respective scale. See Minimum Thickness reference chart in section 10.2.

The **Verification Mode** function allows the user to take measurements while keeping those results out of the valid test data. The results are not stored in the data file, are not included in the statistics nor send to DataView when this function is enabled.

Time & Date Setting

The time and date feature.

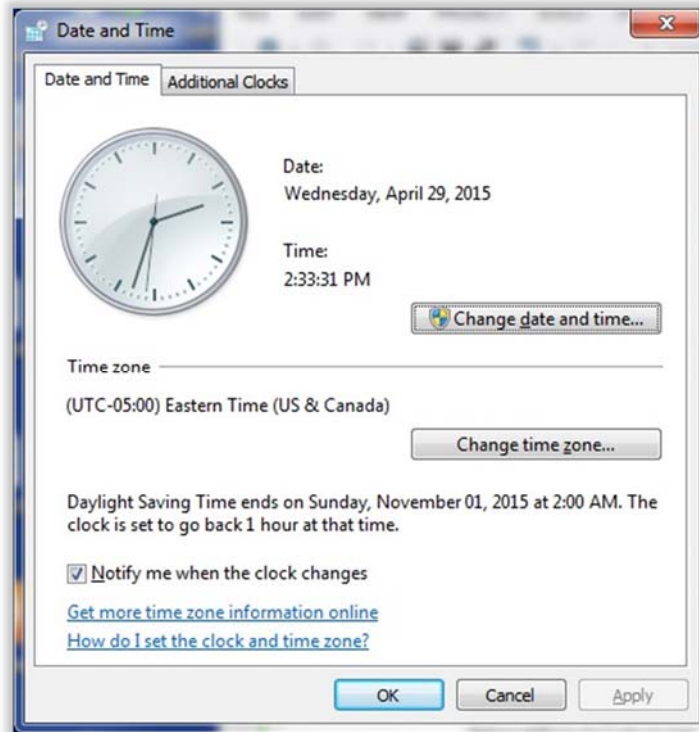

5.25 Technician Screen

The technician screen is password protected and it requires a “Technician” password to be accessed (see section 5.9). It allows the technician to select **Hardness Scale**, to **Adjust** measurements and set **Indirect Calibration** or **Restore Factory Calibration** settings.

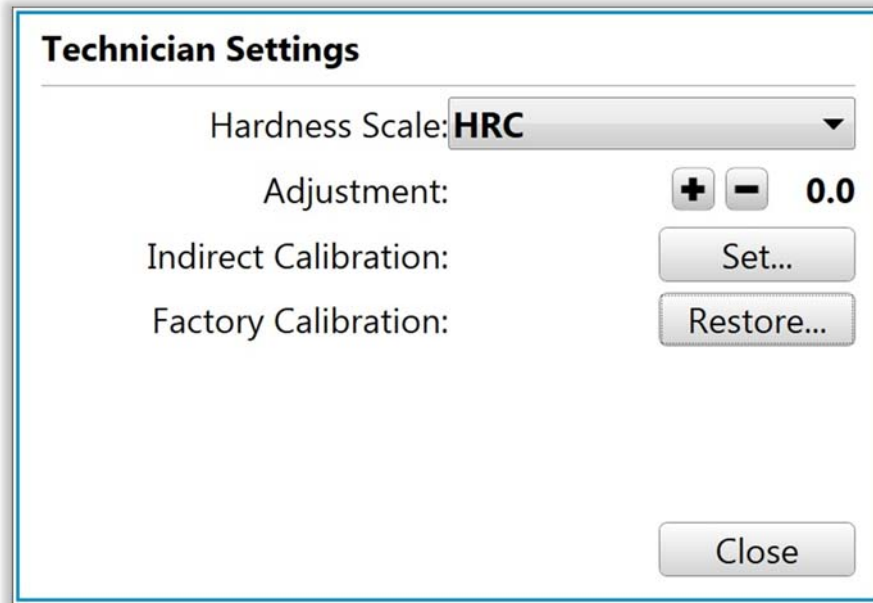

The **Adjustment** function allows the technician to make corrections to a measurement up to +/- 2.0 counts in 0.2 increments. This will be applied to all measurements made on that scale, until it is turned off.

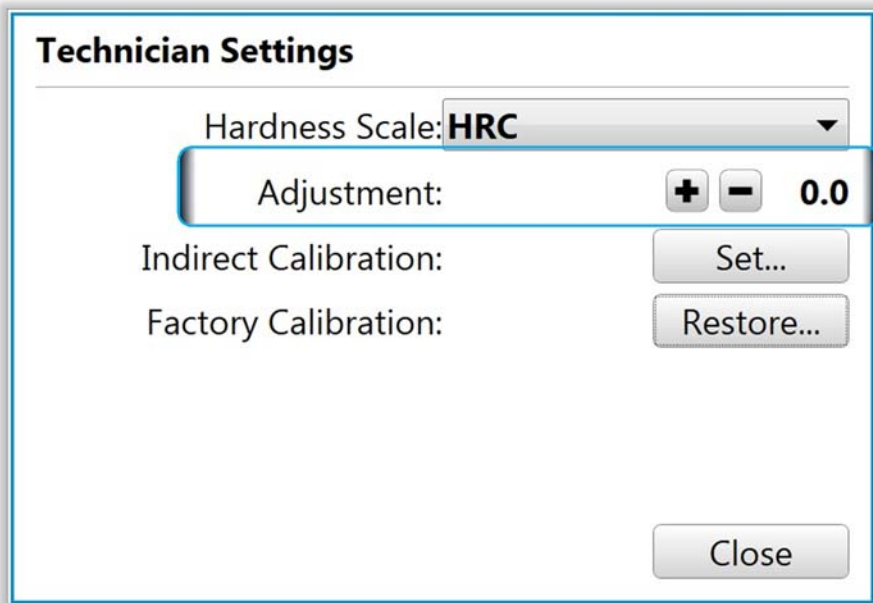

An asterisk will display on the Test Screen by the reading value when this function is enabled.

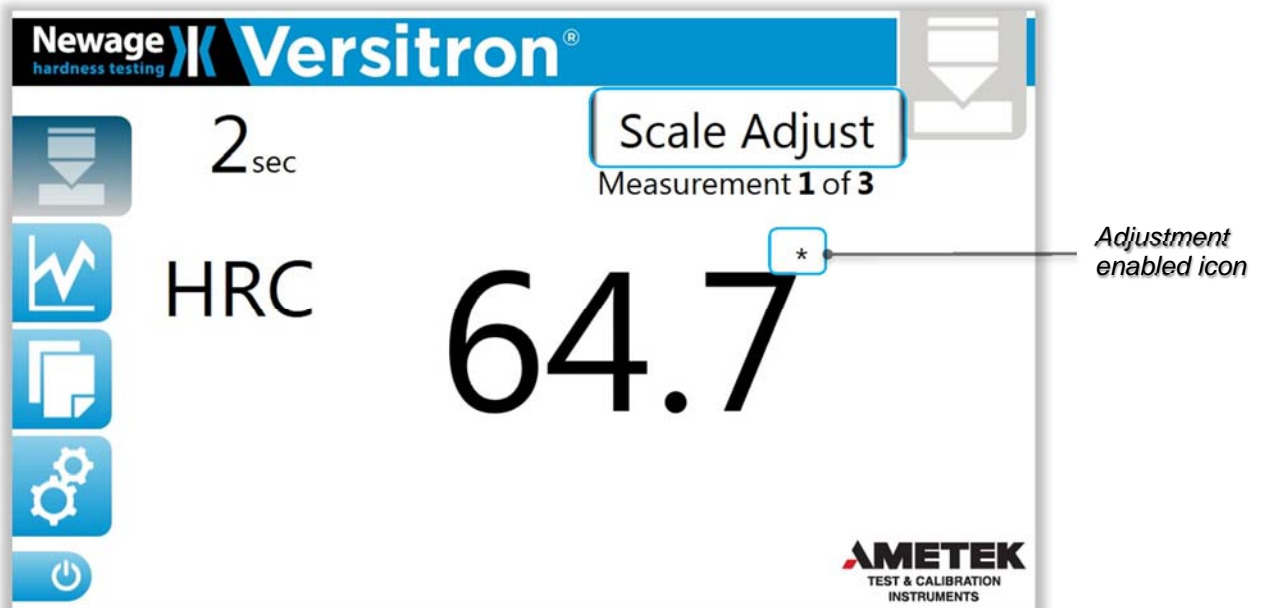

The **Indirect Calibration** option allows a qualified technician to indirectly calibrate the equipment by establishing a new profile set of data points per a specific hardness scale, indenter type or machine (both) using a multi set of scale hardness reference blocks. This process should only be performed by a knowledgeable technician, as it can drastically affect measurement accuracy. This process is not required for normal operation.

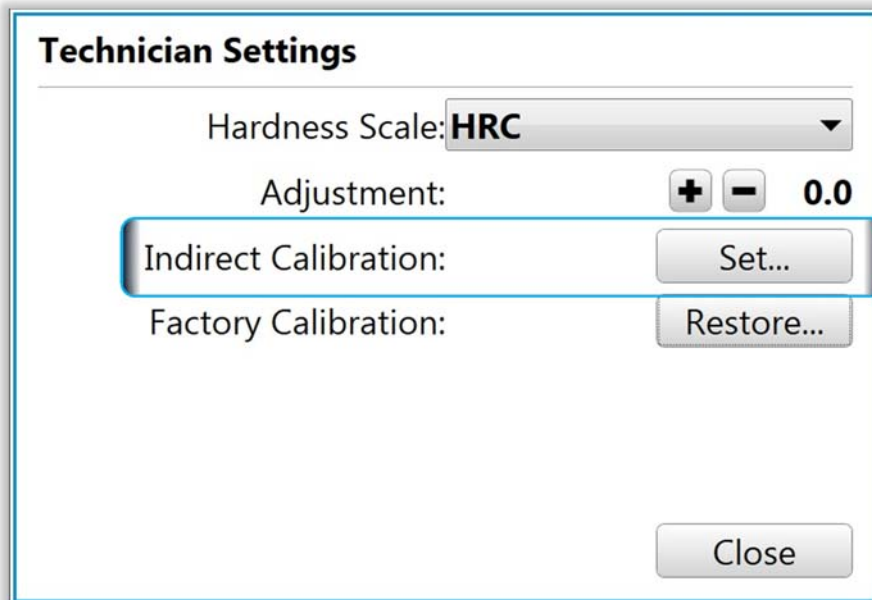

The **Factory Calibration Restore** function allows the technician to remove any previously performed Indirect Calibrations and recovers the system to the original Factory Calibration settings, it's prompted by a confirmation screen to accept or cancel this selection.

Technician Settings

Hardness Scale: **HRC** ▼

Adjustment: **+** **-** **0.0**

Indirect Calibration: **Set...**

Factory Calibration: **Restore...**

Close

Indirect Calibration

This will remove any Indirect Calibrations you have performed and restore the calibration to the Factory Calibration. Are you sure you want to continue?

OK **Cancel**

5.26 User Settings

Some functions are password protected and they require either a “Supervisor” or “Technician” password to be accessed. See previous sections for directions of these functions.

Function	Operator	Supervisor	Technician
Look at Statistics	X	X	X
Delete last measurement	X	X	X
Export Data	X	X	X
Turn DataView On/Off	X	X	X
Select previously created configuration	X	X	X
Show minimum thickness	X	X	X
Set Date/Time	X	X	X
Delete Data file		X	X
Create, Edit, Rename, Delete a configuration		X	X
+/- Adjust			X
Calibration			X

Password Levels

6.0 INDIRECT CALIBRATION

The Indirect Calibration should not be revised on a routine basis. The process consists of three optional indirect calibration levels: **Machine** level, **Indenter** level and **Hardness Scale** level. The **Machine** calibration level is the broadest and more extensive method as it incorporates both the indenter and the hardness scale approaches, it requires a minimum of three different reference blocks per hardness scale range and it's recommended to take a minimum of three readings per reference block per indenter type (diamond and ball). The **Indenter** calibration level is more suitable for applications where the use of different indenters (ball and diamond) is the norm. The **Hardness Scale** calibration level approach is more practical to applications where a specific group of hardness scales is used on a regular basis, it requires a minimum of three different reference blocks per hardness scale and it's recommended to take a minimum of three readings per reference block covering all the hardness scales intended to be used.

The Indirect Calibration function can be accessed from the **Advanced Settings** screen under the **Technician** option. This option is password protected and it requires the technician to enter the passcode "5678" at the keypad prompt.

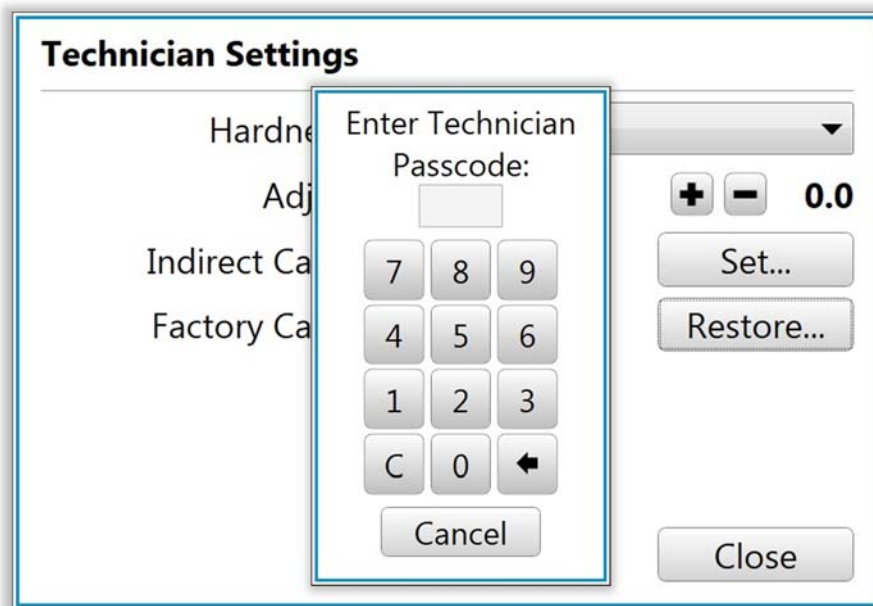

After a successful entry the technician can select the Indirect Calibration **Set** tab to access this function, the **Indirect Calibration** screen will prompt, with the three optional calibration levels; **Machine**, **Indenter** and **Hardness Scale**.

Indirect Calibration

Select IndirectCal Type:

- Machine
- Indenter
 - diamond
- Hardness Scale
 - HRA

Select

Apply Cancel

Check the applicable calibration level, for **Indenter** and **Hardness Scale** calibration, the technician needs to select an indenter type or a hardness scale from the drop down list of options. After making the appropriate choice click **Select**, an empty **New Reference Readings** data grid will appear to the right of the screen, with two option tabs; to **Add** and **Delete** readings.

Indirect Calibration

Select IndirectCal Type:

- Machine
- Indenter
 - diamond
- Hardness Scale
 - HRA

New Reference Readings

Reference	Reading	Scale

Add... Delete

Apply Cancel

Click on the **Add** tab will prompt the **Add a New Reading** screen, choose the hardness scale you are interested in calibrating first from the drop down list of hardness scale options.

Add a New Reading:

Reference Hardness: 51.2 HRC

Apply

Reading:

Time at Load:

Cancel

Tap on the **Reference Hardness** box, at the prompted keypad, type the test block hardness reference value stamped on the test block and hit **Enter**.

Add a New Reading

Reference Ha .2 HRC

Apply

R

Time a

Enter Reference Hardness: 51.20

7 8 9

4 5 6

1 2 3

. 0 ←

Enter

Cancel

Click the **Apply** tab will prompt the **Capstan Wheel Adjustment** screen, adjust the capstan wheel to the optimum load position and when ready click **Done**.

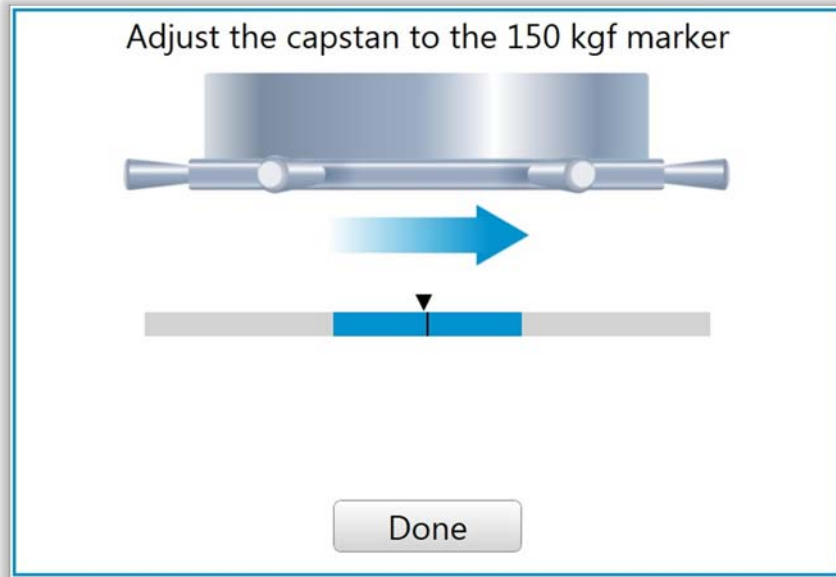

The **Add a New Reading** screen is now ready for the first measurement to be executed. Place the corresponding test block on the anvil and proceed to take the first measurement by operating the arm lever or foot pedal, click **OK** if satisfy with the reading or **Cancel** to retake the measurement.

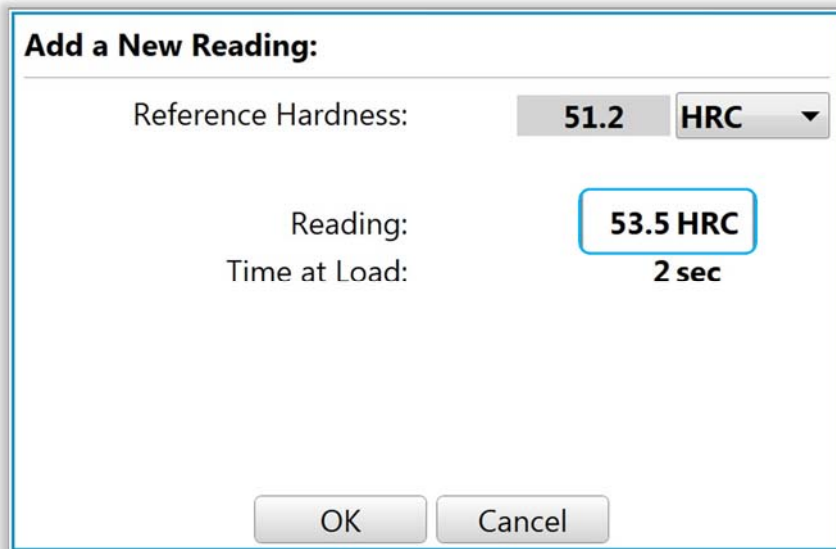

When the first measurement is completed, the **Indirect Calibration** screen will appear with the data grid listing the Reference value, the actual Reading and the Scale used. Click the **Add** tab and repeat the process using the same test block but at a different location, until achieving a total of at least three successful readings for the selected hardness scale. If for any reason the technician is not satisfy with any of the readings, select that specific reading(s) and click the **Delete** tab to discard it.

Indirect Calibration

Select IndirectCal Type:

Machine
 Indenter
 Hardness Scale

New Reference Readings

Reference	Reading	Scale
60.35	62.7	HRC
60.35	62.5	HRC
60.35	62.5	HRC
51.2	54.1	HRC
51.2	53.9	HRC

When the final measurement is completed click the **Add** tab to add another reading using a different reference block, enter the new reference block value and repeat the previous process to achieve a second set of readings under the new scale range. A third reference block scale range must be used for a third set of readings for a minimum of nine readings (at least three for each reference block scale range). If calibrating multiple scales indenter of complete machine, repeat the same process selecting a different hardness scale but with the same indenter type. When all readings have been completed click Apply to confirm and accept the new indirect calibration profile data points. That concludes the indirect calibration process.

For a more comprehensive list of standardized reference test blocks and hardness ranges test points, see the reference table from section 9.6.

7.0 SPECIFICATIONS

7.1 TECHNICAL SPECIFICATIONS BT130 (T-Stands)

The T-Stand is the most versatile and utilizes the top-loading feature to its maximum. There are two vertical adjustments; one for elevating screw testing and one which moves the entire head holder along two columns for use when the anvil stage is removed.

Frame Construction	Cast Iron & Steel Rod
Vertical Capacity (w/out Anvil Stage)	406mm (16.0in)
Vertical Capacity (with Anvil Stage)	246mm (9.7in)
Horizontal Capacity	223mm (8.8in)
Throat Depth	223mm (8.8in)
Approximate Weight	63.5kg (266lb)

7.2 T-Stand OVERALL DIMENSIONS

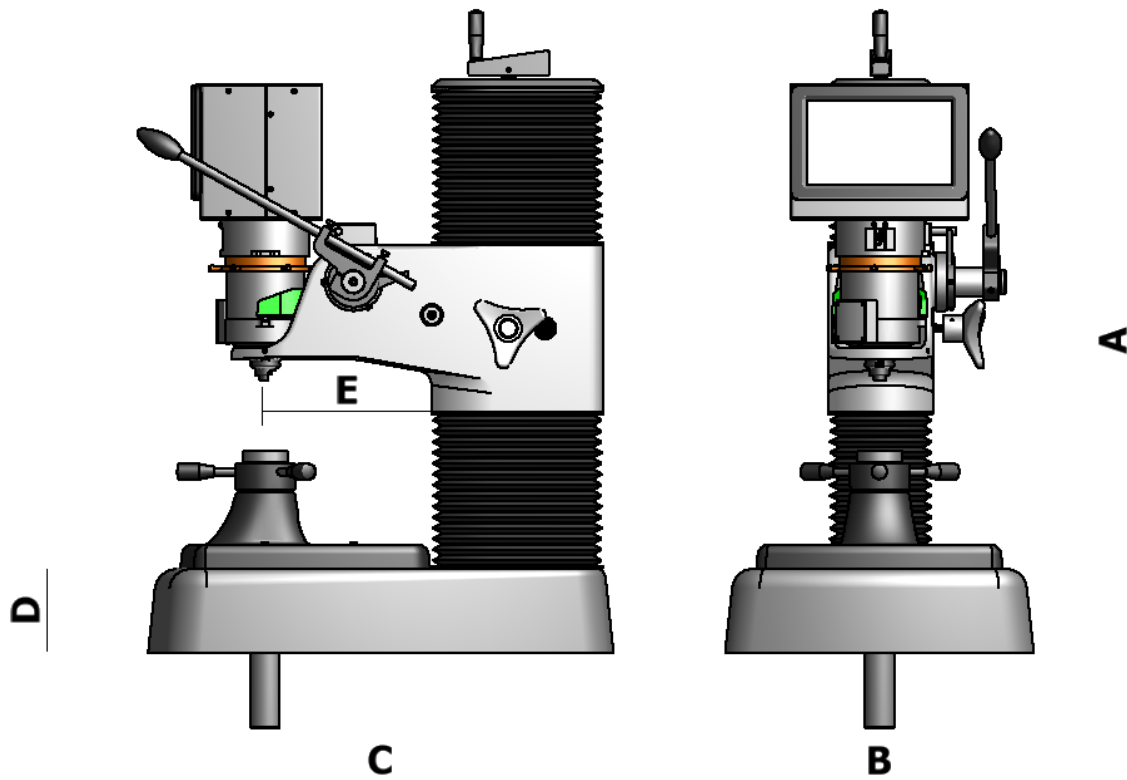

BT130T		mm	in
A	Max. Height	870	34.2
B	Max. Width	419	16.5
C	Max. Depth	632	24.9
D	Base Height	114	4.5
E	Max. Throat Depth	223	8.8

7.3 TECHNICAL SPECIFICATIONS BT130 (N-Stands)

Frame Construction	Cast Iron
Vertical Capacity	208mm (8.2in)
Horizontal Capacity	198mm (7.8in)
Throat Depth	219mm (8.7in)
Approximate Weight	63.5kg (140lb)

7.4 N-Stand OVERALL DIMENSIONS

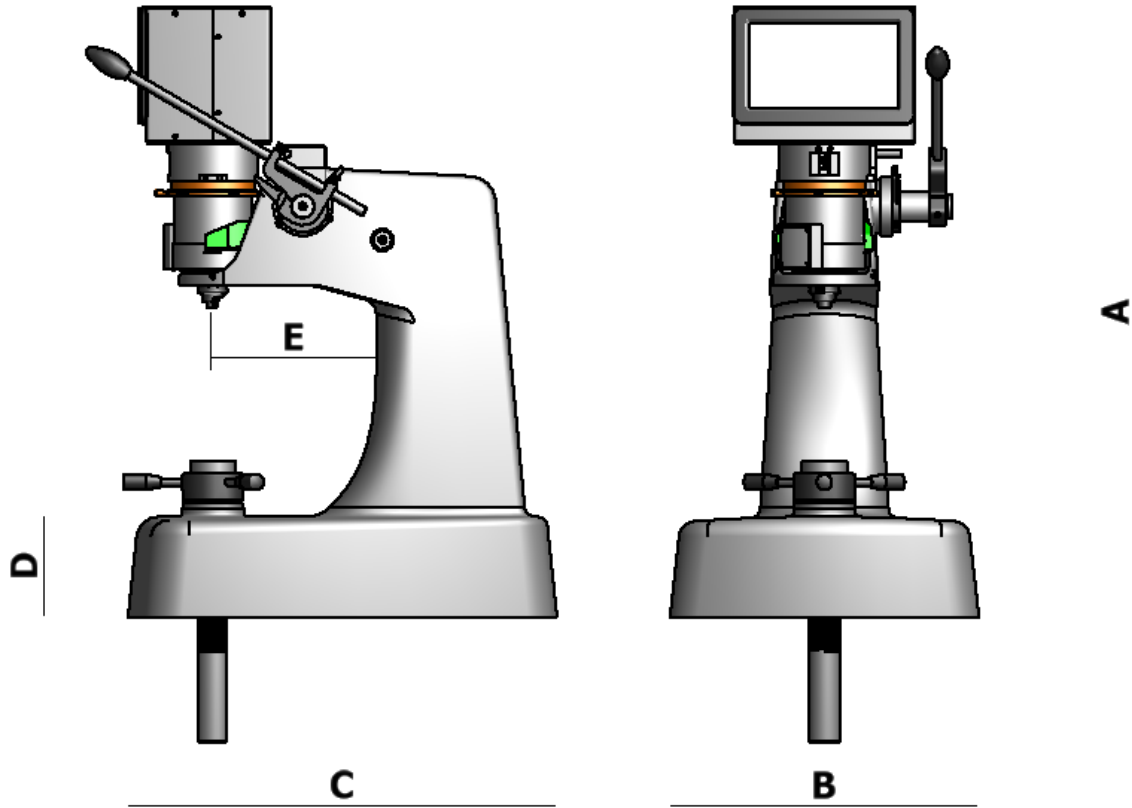

BT130N		mm	in
A	Max. Height	813	32.0
B	Max. Width	412	16.2
C	Max. Depth	572	22.5
D	Base Height	134	5.3
E	Max. Throat Depth	219	8.7

7.5 TECHNICAL SPECIFICATIONS BT130R & BT130S Test Heads

Displayed Hardness Resolution	0.1 Rockwell
Supply Voltage	115 or 230+/-10%VAC
Supply Frequency	50-60Hz
Power Rating	230VAC @3.15A
Fuses (2)	T3A15H250V(3.15ASlow Blow Ceramic)
Weight of Test Head	8kg (18lb)

BT130R tests in Regular Rockwell scales with full loads of 60, 100 and 150 Kg with a preload of 10 Kg. Conforms to ASTM E18.

BT130S tests in Superficial Rockwell scales with full loads of 15, 30 and 45 Kg with a preload of 3 Kg, Conforms to ASTM E18.

7.6 Test Head OVERALL DIMENSIONS

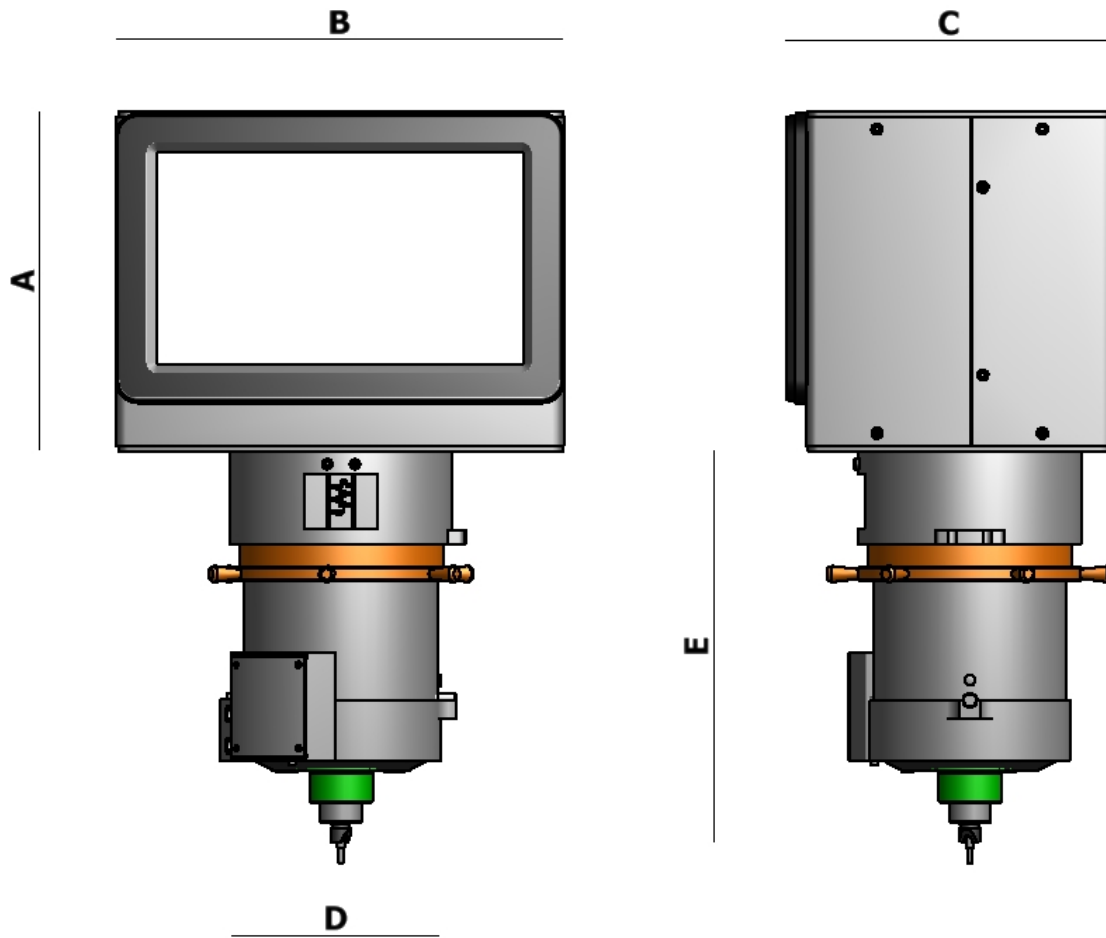

BT130R & BT130RS		mm	in
A	Control Unit Height	183	7.2
B	Control Unit Width	241	9.5
C	Control Unit Depth	178	7.0
D	Head Width	112	4.4
E	Head Height	211	8.3

7.7 DataView Output Specifications

- USB Type B (located on back of the console).
- The following is the format of the DataView output of test values:
#####:bbbHHHHHSSSSSbTT where:
= The sequence number
b = blank space
HHHHH = The hardness result
SSSSS = The scale ID
TT = The tolerance indicator (High, Low, Ok)
- Data Export
To USB Drive. USB Type A connector I (located on at the bottom of the console).
Export of stored data (this is not a live data feed).
The data file is a “.csv” format file containing measurement and scale only.

The total length is 22 characters. All 22 characters are printed regardless of whether or not tolerance values are set. If tolerance values are not specified, the last 3 characters are blanks.
- The format of the individual bytes is as follows:
1 start bit
1 stop bit
8 data bits
No parity
9600 Baud
- Carriage ret. And Line Feed Messages are sent after the 22 character string.



NOTE: Physical connections must be made before launching DataView. A USB Device Driver (provided on accompanying CD) must be loaded on the DataView computer prior to the initial use.



NOTE: Measurements made in verification mode are not stored in the data file.

7.8 Standard Accessories

These accessories and parts are included in the accessory kit provided with each test head.

- (1) Diamond indenter for Regular or Superficial scale (normally installed on test head, not in kit).
- (1) 1/16" ball indenter
- (2) Test blocks
- (1) Calibration lock
- (2) Pin wrenches
- (1) USB Device Driver install CD (for connection to external PC).

These accessories and parts are included with each test stand.

BT130N (1) Clamping shield; (1) set of Allen wrenches, (1 each) 2" flat, spot, shallow and wide Vee anvil; (1) accessory case; (1) vinyl protective cover

BT130T, (1) Removable anvil stage; (1) anvil stage wrench; (1) clamping shield; (1) spindle lock; (1) set of Allen wrenches (1 each) 2" flat, spot, shallow and wide Vee anvils; (1) anvil base adapter; (1) accessory case; (1) vinyl protective cover

BT130-MT1, BT130-MT2 Automatic assemblies include the same accessories as the Standard Versitron

7.9 Options and Other Accessories

(See following pages for drawings of indenter shrouds and clamping shields)

These accessories may be purchased for special applications. See following pages for illustrations

Newage Part Number	Description
AT/5116W	1/16" carbide ball
AT/5117W	1/8" carbide ball
AT/	1/4" carbide ball
AT/5118	Cap only for 1/16" ball indenter
AT/5119	Cap only for 1/8" ball indenter
AT/5309	Diamond spot anvil
AT/5310	Two inch spot anvil
AT/5311	Spot anvil
AT/5312	Shallow Vee anvil
AT/5313	Wide Vee anvil
AT/5316	Large taper testing anvil
AT/5318	Small anvil with reducer
AT/5319	Flattened ball anvil, for tapered faces
AT/5320	Clamping shield, fits all stands

AT/5321	Shortened clamping shield (for Motorized)
AT/5322	Anvil adapter to fit 3/4" diameter anvil posts
AT/5401	Normal indenter shroud
AT/5402	Enclosed indenter shroud
AT/5404	Fully enclosed pointed nose indenter shroud for tapered diamond
AT/5405	1.7" enclosed pointed nose indenter shroud
AT/5411	4" indenter shroud & clamping shield extension
AT/5412	1.7" penetrator, indenter shroud & clamping shield extension
AT/5413	1" indenter, indenter shroud & clamping shield extension
AT/5414	1.7" double tapered indenter, indenter shroud extension
AT/5415	1" double tapered indenter, indenter shroud extension
AT/5416	Fully enclosed clamping shield
AT/5510	Flexible arm electric light, on-off switch, holding fixture, 110 V transformer and power cord.
AT/5535	Acoustic alarm for use on BT130-R and BT130S digital test heads. (Must be ordered when test head is purchased).
AT/5620	Vinyl protective cover for T and N stands

Replacement Parts

AT-82T	Locking knob on T Stands
AT-13TR	Rubber elevating screw cover
AT-102T	Anvil base adapter
AT-14T	Yoke
AT-68T	Yoke bearing
AT-48T	Lever
AT-76T	Head carriage height adjustment knob
AT-97T	Top handle only (part of 76T)
AT130B	Floor Cabinet. Holes are cut for elevating screw. Has one drawer. Measures 24½"W x 28"D x 34"H.

Part #	Regular	Superficial	Indenter/Ball Size
5106*	-	All N Scales	Diamond
5107*	C, A		Diamond
5110	C, D		
5111**	B, F, G	All T Scales	1/16"
5112**	E, H, K	All W Scales	1/8"
5113**	L, M, P	All X Scales	1/4"

* Tapered diamond for use with Indenter Shroud #5404.

** When ordering Ball Indenter, please supply test Head serial number to ensure proper fit. The serial number is located on the silver capstan load wheel and on the label on the back of the head.

Diamond Ball Indenters

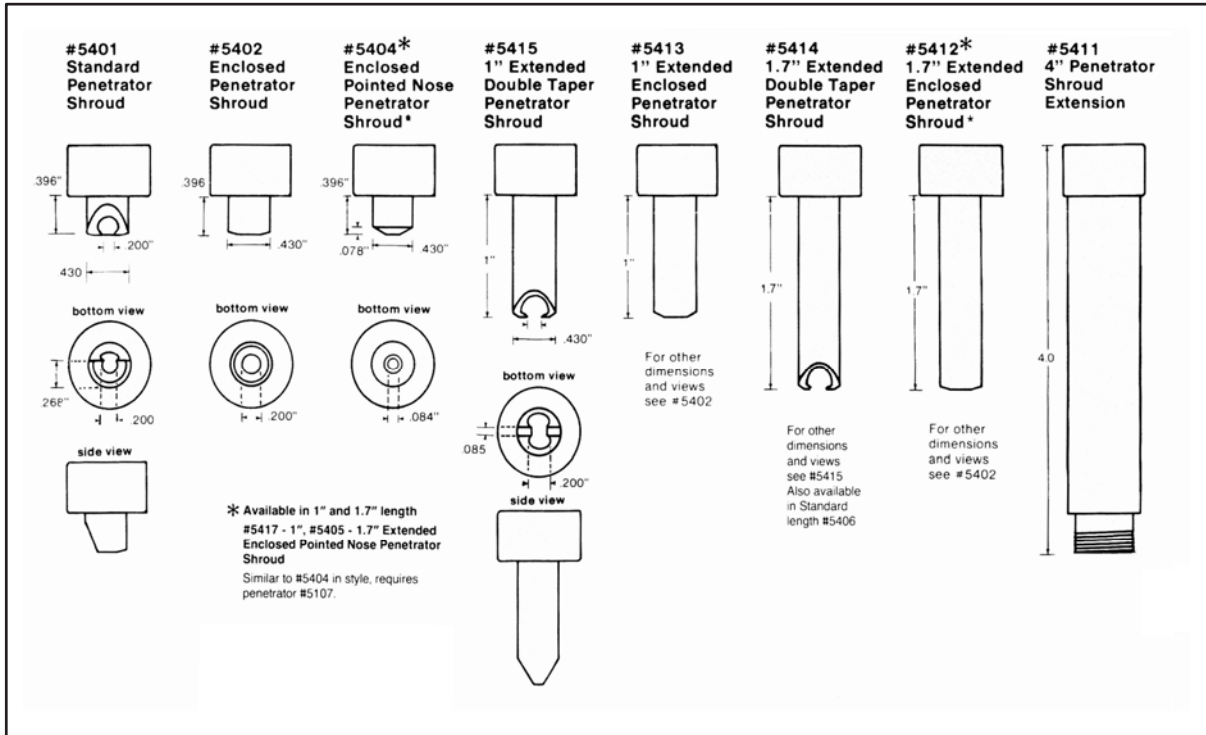

Indenter Shroud Dimensions

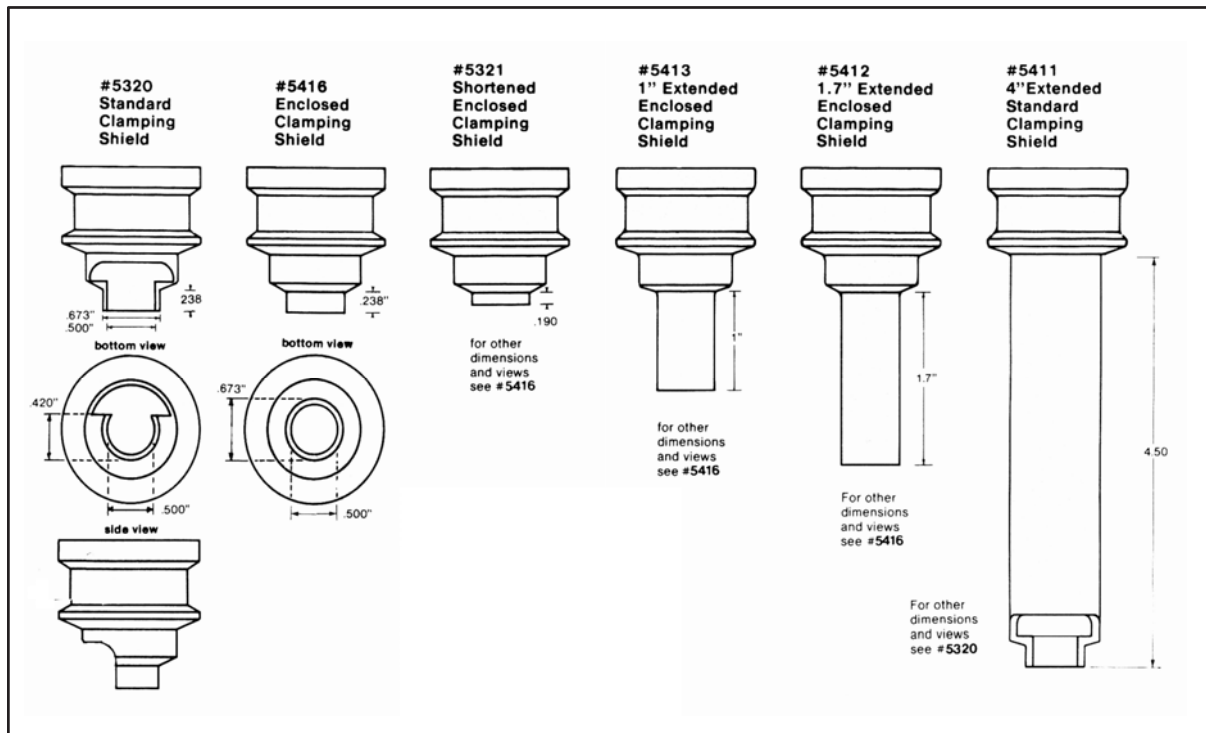

Clamping Shield Dimensions

8.0 MAINTENANCE & TROUBLESHOOTING

8.1 Maintenance Procedures

The Versitron needs no regularly scheduled maintenance other than calibration. For highest accuracy; anvils, indenters and indenter shrouds should be checked for damage and dirt on an occasional basis or when changed. The Vee anvil alignment should also be checked regularly especially before testing small diameter rounds.

8.2 Troubleshooting “What Not To Do”

Do not open the test head except at the direction of the Newage Customer Service manager. Unauthorized opening of the test head voids the warranty.

If you think you may need service, please review the troubleshooting guide before you call in so that Newage will be in a position to provide assistance. Newage is eager to provide service and assistance, but our ability to help will be hampered by inadequate information.

8.3 Troubleshooting “What to Do” Before You Call Newage

- Get the model and serial number of the tester, indicated on the label on the back of head.
- Get an exact description of the problem, be as specific as possible.
- Review the Pre-Troubleshooting Checklist and verify the tester is being used correctly.
- Review Section Troubleshooting Guide to see if the problem is easily corrected at your facility.

8.4 Pre-Troubleshooting Checklist

(Review appropriate section in manual for corrective action.)

- Are the correct loads and indenter being used for the desired scale?
- Is the Indenter shroud properly installed?
- Is the contact area worn or deformed? (If questionable, substitute another shroud if available).
- Is the indenter chipped or flattened? (If questionable, substitute for a different indenter and check calibration).
- If checking round specimens, is the Vee anvil alignment O.K.?
- Is the test head installed properly?
- Is the stand set up correctly?
- Are all the connectors tight and the power on?

If all these items have been checked, please continue to the next section.

8.5 Troubleshooting Checklist

Symptom	Problem	Check/Remedy
Low readings on test block	Bad test Block.	Try a different test block.
	Bad Indenter.	Substitute new Indenter or switch from diamond indenter to ball or vice versa and check calibration on appropriate test block.
	Loose Indenter or Shroud.	Check for finger tightness (see Section 4.6)
	Inaccurate test load.	Check for proper load selection.
	Test positions too close to edge or to each other.	Make test more than 3 impression diameters apart or from the edge.
	Specimen dirty or deformation on Indenter seat or Indenter Shroud seat.	Remove Indenter and Shroud and clean contact areas at both ends or substitute a new component and clean.
High reading on part.	Bad test block.	Try a different test block.
	Test indentations too close together.	Keep test indentations 2 ½ diameters apart.
	Bad Indenter.	Substitute Indenters or switch from ball to diamond and retest on test block.
	Time-at-load not long enough (especially on softer materials).	Set time-at-load for 6 seconds
	Inaccurate test load.	Check for proper load and selection.
	No round correction factor.	If testing on round specimens under 1 ½ ", (see Section 8.3).
	Vee anvil misalignment.	See Section 4.14

Symptom	Problem	Check/Remedy
High reading on part.	Metal too soft to support Indenter Shroud (especially when testing inside diameters).	Look at test impression to see if the Shroud makes foot print.
	Test specimen does not meet minimum thickness requirements.	Test on test block (see Section 8.2).
	Missing or sticking lower probe.	Remove Indenter and check to see if probe drops down (see Section 4.9).
	Test specimen positioned too far from the Indenter.	Raise specimen to within 1/16" of Indenter.
	Indenter protruding more than .030" from the bottom of the Indenter Shroud.	Substitute Indenter and/or Shroud and retest.
	Indenter Shroud contacting raised edges of nearby impression.	Test in another area free of impressions.
	Lever system out of stroke.	Realign red dots (see Section 3.4).
Erratic readings.	Damaged Indenter.	Replace Indenter or substitute ball for diamond (or vice-versa) and retest on appropriate test block.
	Dirt or deformation of Indenter seat or Indenter Shroud seat.	Remove Indenter & Shroud and clean or replace components and retest.
	Test specimen surface too rough.	Test on test block.
	Wavy washer missing from inside of Indenter Shroud.	Remove Shroud and check inside the top of the Shroud for a wavy washer.
	Head height adjustment not locked (T-Stand).	Check head height adjustment locking knob for tightness.

Symptom	Problem	Check/Remedy
Erratic readings.	Part not clamped tight enough (if using clamping shield with large parts).	Check for movement or looseness of specimen and check for adequate tightening of elevating.
No display	No power to test head.	Check cord and power supply, check fuse and check switch
Flickering display	Fuse blown. Erratic power connection.	Check power cord, cable and power supply source.
Breaking diamonds.	Specimen not stable under load.	Clamp on fixture specimen.
	Bad Vee alignment.	Align Vee anvil.
	Base plate not tighten properly (T-Stands).	Tighten knob.
	Head height locking knob not set tight.	Tighten knob.
Application does not load	Testing too close to edge of specimen.	Test further from edge.
	USB drive is Default boot drive and computer	Make sure nothing is plugged into the USB A port at the bottom of the console during start up.

9.0 VERSITRON FACTORY SERVICE & SHIPPING INSTRUCTIONS

MAKE CERTAIN YOUR INSTRUMENT NEEDS TO BE SERVICED:

Test Stands: Usually, broken parts on the test stand portion of your Versitron can be installed at your plant by your maintenance personnel or Newage representative. Call Newage Customer Service Department if you need assistance.

Test Heads: If the test head will not operate correctly after following the troubleshooting procedures and/or calling Newage support personnel, see below for shipping instructions:

IF YOUR TESTER DOES NEED SERVICE:

The indenter and its shroud should be screwed into the head. Any additional indenters should also be included in shipment.

Write the name and phone number of a person who can authorize the repair expense. (Newage will call with an estimate after looking at the tester. Note: There is a bench fee if the repair is declined) Also, include a brief description of the tester problem or requirement, e.g. *Needs calibration* or *Reads high*.

Place head, and related accessories in a sturdy box (double-wall cardboard or double boxed, leaving room for at least three (3) inches of fire packing material).

Pack the box so the head will not shift in shipment and be certain the indenter and dial indicator or electronics will not be damaged by movement of the head. Mark package with labels indicating "Sensitive Instrument. Handle with care".

Ship via UPS and insured for the value of the test head.

Ship to:

Newage Testing Instruments, Inc.
820 Pennsylvania Blvd, Feasterville, PA 19053 USA
Tel: 215-355-6900, Fax: 215-354-1803



NOTE: Emergency Service: Immediate service is available on emergency cases where the test head is to be shipped in via overnight shipment. Call 215-355-6900 and request fast turnaround and return shipment by air freight. We must know your test head is coming and be able to verify that personnel will be available to do the work.



NOTE: When packaging delicate instruments for shipment maximum care must be taken. Please instruct your shipping department to take as many precautions as they can.



NOTE: Newage policy for warranty repairs is for customer to pay shipping to Newage. Newage will pay charges for shipment back to customer.

Shipping Test Stands

Test stands must be crated or bolted to a skid (there are four M12 threaded holes on the underside of the stand) and protected with cardboard or similar. Follow same procedures regarding insurance and instructions.

10.0 REFERENCE TABLES, ASTM E18

10.1 Rockwell Scale Reference Table

Scale Symbol	Indenter	Major Load	Dial Figures, kgf	Typical Application of Scales
B	1/16-in. (1.588mm) ball	100	Red	Copper alloys, soft steels, aluminum alloys, malleable iron, etc.
C	diamond	150	Black	Steel, hard cast irons, pearlitic malleable iron, titanium, deep case hardened steel and other materials harder than B 100.
A	diamond	60	Black	Cemented carbides, thin steel, shallow case-hardened steel.
D	diamond	100	Black	Thin steel and medium case hardened steel, and pearlitic malleable iron.
E	1/8-in. (3.175-mm) ball	100	Red	Cast iron, aluminum and magnesium alloys, bearing metals.
F	1/16-in. (1.588-mm) ball	60	Red	Annealed copper alloys, thin soft sheet metals.
G	1/16-in. (1.588-mm) ball	150	Red	Malleable irons, copper-nickel-zinc and cupro-nickel alloys.
H	1/8-in. (3.175-mm) ball	60	Red	Aluminum, zinc, lead.
K	1/8-in. (3.175-mm) ball	150	Red	Bearing metals and other very soft or thin materials. Use smallest ball and heaviest load that does not give anvil effect.
L	¼-in. (6.350-mm) ball	60	Red	
M	¼-in. (6.350-mm) ball	100	Red	
P	¼-in. (6.350-mm) ball	150	Red	
R	½-in. (12.70-mm) ball	60	Red	
S	½-in. (12.70-mm) ball	100	Red	
V	½-in. (12.70-mm) ball	150	Red	

10.2 Minimum Thickness

NOTE—For a given thickness, any hardness greater than that corresponding to that thickness can be tested. For a given hardness, material of any greater thickness than that corresponding to that hardness can be tested on the indicated scale.

*These approximate hardness numbers are for use in selecting a suitable scale and should not be used as hardness conversions. If necessary to convert test readings to another scale, refer to the ASTM Standard Hardness Conversion Tables E 140 for Metals (Relationship Between Brinell Hardness, Vickers Hardness, Rockwell Hardness, Rockwell Superficial Hardness, and Knoop Hardness.)

Minimum allowable thickness for a corresponding hardness in the respective scales.

MINIMUM THICKNESS in.	MINIMUM THICKNESS mm	ROCKWELL			SUPERFICIAL ROCKWELL					
		C	A	B	15N HARDNESS READING	30N HARDNESS READING	45N HARDNESS READING	15T HARDNESS READING	30T HARDNESS READING	45T HARDNESS READING
.006	0.15	92
.008	0.20	90
.010	0.25	88	91
.012	0.30	83	82	77	86
.014	0.36	76	78.5	74	81	80	...
.016	0.41	...	86	...	68	74	72	75	72	71
.018	0.46	...	84	66	68	68	64	62
.020	0.51	...	82	57	63	...	55	53
.022	0.56	69	79	47	58	...	45	43
.024	0.61	67	76	94	51	...	34	31
.026	0.66	65	71	87	37	18
.028	0.71	62	67	80	20	4
.030	0.76	57	60	71
.032	0.81	52	...	62
.034	0.86	45	...	52
.036	0.91	37	...	40
.038	0.96	28	...	28
.040	1.02	20

The above table is from ASTM E 18.

Charts reprinted from ASTM Handbook

10.3 Round Correction

ROUND CORRECTION

Corrections to be added to **Rockwell C, A, and D** values obtained on convex cylindrical surfaces or various diameters

HARDNESS READING	DIAMETERS OF CONVEX CYLINDRICAL SURFACES								
	1/4 in. (6.4 mm)	3/8 in. (10 mm)	1/2 in. (13 mm)	5/8 in. (16 mm)	3/4 in. (19 mm)	7/8 in. (22 mm)	1 in. (25 mm)	1-1/4 in. (32 mm)	1-1/2 in. (38 mm)
20	6.0	4.5	3.5	2.5	2.0	1.5	1.5	1.0	1.0
25	5.5	4.0	3.0	2.5	2.0	1.5	1.0	1.0	1.0
30	5.0	3.5	2.5	2.0	1.5	1.0	1.0	1.0	0.5
35	4.0	3.0	2.0	1.5	1.0	1.0	1.0	0.5	0.5
40	3.5	2.5	2.0	1.5	1.0	1.0	1.0	0.5	0.5
45	3.0	2.0	1.5	1.0	1.0	1.0	0.5	0.5	0.5
50	2.5	2.0	1.5	1.0	1.0	0.5	0.5	0.5	0.5
55	2.0	1.5	1.0	1.0	0.5	0.5	0.5	0.5	0
60	1.5	1.0	1.0	0.5	0.5	0.5	0.5	0	0
65	1.5	1.0	1.0	0.5	0.5	0.5	0.5	0	0
70	1.0	1.0	0.5	0.5	0.5	0.5	0.5	0	0
75	1.0	0.5	0.5	0.5	0.5	0.5	0	0	0
80	0.5	0.5	0.5	0.5	0.5	0	0	0	0
85	0.5	0.5	0.5	0	0	0	0	0	0
90	0.5	0	0	0	0	0	0	0	0

Corrections to be added to **Rockwell B, F, and G** values obtained on convex cylindrical surfaces or various diameters

HARDNESS READING	DIAMETERS OF CONVEX CYLINDRICAL SURFACES						
	1/4 in. (6.4 mm)	3/8 in. (10 mm)	1/2 in. (13 mm)	5/8 in. (16 mm)	3/4 in. (19 mm)	7/8 in. (22 mm)	1 in. (25 mm)
0	12.5	8.5	6.5	5.5	4.5	3.5	3.0
10	12.0	8.0	6.0	5.0	4.0	3.5	3.0
20	11.0	7.5	5.5	4.5	4.0	3.5	3.0
30	10.0	6.5	5.0	4.5	3.5	3.0	2.5
40	9.0	6.0	4.5	4.0	3.0	2.5	2.5
50	8.0	5.5	4.0	3.5	3.0	2.5	2.0
60	7.0	5.0	3.5	3.0	2.5	2.0	2.0
70	6.0	4.0	3.0	2.5	2.0	2.0	1.5
80	5.0	3.5	2.5	2.0	1.5	1.5	1.5
90	4.0	3.0	2.0	1.5	1.5	1.5	1.0
100	3.5	2.5	1.5	1.5	1.0	1.0	0.5

Corrections to be added to **Superficial Rockwell 15N, 30N, and 45N** values obtained on convex cylindrical surfaces or various diameters

HARDNESS READING	DIAMETERS OF CONVEX CYLINDRICAL SURFACES					
	1/8 in. (3.2 mm)	1/4 in. (6.4 mm)	3/8 in. (10 mm)	1/2 in. (13 mm)	3/4 in. (19 mm)	1 in. (25 mm)
20	6.0	3.0	2.0	1.5	1.5	1.5
25	5.5	3.0	2.0	1.5	1.5	1.0
30	5.5	3.0	2.0	1.5	1.0	1.0
35	5.0	2.5	2.0	1.5	1.0	1.0
40	4.5	2.5	1.5	1.5	1.0	1.0
45	4.0	2.0	1.5	1.0	1.0	1.0
50	3.5	2.0	1.5	1.0	1.0	0.5
55	3.5	2.0	1.5	1.0	0.5	0.5
60	3.0	1.5	1.0	1.0	0.5	0.5
65	2.5	1.5	1.0	0.5	0.5	0.5
70	2.0	1.0	1.0	0.5	0.5	0.5
75	1.5	1.0	0.5	0.5	0.5	0
80	1.0	0.5	0.5	0.5	0	0
85	0.5	0.5	0.5	0.5	0	0
90	0	0	0	0	0	0

Corrections to be added to **Superficial Rockwell 15T, 30T, and 45T** values obtained on convex cylindrical surfaces or various diameters

HARDNESS READING	DIAMETERS OF CONVEX CYLINDRICAL SURFACES						
	1/8 in. (3.2 mm)	1/4 in. (6.4 mm)	3/8 in. (10 mm)	1/2 in. (13 mm)	5/8 in. (16 mm)	3/4 in. (19 mm)	1 in. (25 mm)
20	13.0	9.0	6.0	4.5	4.5	3.0	2.0
30	11.5	7.5	5.0	3.5	3.5	2.5	2.0
40	10.0	6.5	4.5	3.5	3.0	2.5	2.0
50	8.5	5.5	4.0	3.0	2.5	2.0	1.5
60	6.5	4.5	3.0	2.5	2.0	1.5	1.5
70	5.0	3.5	2.5	2.0	1.5	1.0	1.0
80	3.0	2.0	1.5	1.5	1.0	1.0	0.5
90	1.5	1.0	1.0	0.5	0.5	0.5	0.5

When testing cylindrical specimens, the accuracy of the test will be seriously affected by alignment of elevating screw, V-anvil, indenters, surface finish, and the straightness of the cylinder. These corrections are approximate only and represent the averages, to the nearest 0.5 Rockwell and Rockwell Superficial numbers, of numerous actual observations. The above tables are from ASTM E 18.

Chart reprinted from *ASTM Handbook*

10.4 Hardness Conversion Chart, Rockwell C Hardness Range

Rockwell C Hardness Range

Approximate Hardness Conversion Numbers for Non-Austenitic Steels, According to ASTM E-140
The Conversion Values contained herein should be considered approximate only and may be inaccurate for specific applications

C 150 kgt diamond	A 60 kgt diamond	D 100kgt diamond	15N 15kgt diamond	30N 30 kgt diamond	45N 45 kgt diamond	Vickers Hardness	Knoop Hardness 500gr and over	Brinell Hardness 3000kgt 10mm ball	Tensile Strength 1000 lbs/ square in
68	85.6	76.9	93.2	84.4	75.4	940	920
67	85.0	76.1	92.9	83.6	74.2	900	895
66	84.5	75.4	92.5	82.8	73.3	865	870
65	83.9	74.5	92.2	81.9	72.0	832	846	(739)	
64	83.4	73.8	91.8	81.1	71.0	800	822	(722)	
63	82.8	73.0	91.4	80.1	69.9	772	799	(705)	
62	82.3	72.2	91.1	79.3	68.8	745	776	(688)	
61	81.8	71.5	90.7	78.4	67.7	720	754	(670)	
60	81.2	70.7	90.2	77.5	66.6	697	732	(654)	
59	80.7	69.9	89.8	76.6	65.5	674	710	(634)	351
58	80.1	69.2	89.3	75.7	64.3	653	690	615	338
57	79.6	68.5	88.9	74.8	63.2	633	670	595	325
56	79.0	67.7	88.3	73.9	62.0	613	650	577	313
55	78.5	66.9	87.9	73.0	60.9	595	630	560	301
54	78.0	66.1	87.4	72.0	59.8	577	612	543	292
53	77.4	65.4	86.9	71.2	58.6	560	594	525	283
52	76.8	64.6	84.4	70.2	57.4	544	576	512	273
51	76.3	63.8	85.9	69.4	56.1	528	558	496	264
50	75.9	63.1	85.5	68.5	55.0	513	542	481	255
49	75.2	62.1	85.0	67.6	53.8	498	526	469	246
48	74.7	61.4	84.6	66.7	52.5	484	510	455	237
47	74.1	60.8	83.9	65.8	51.4	471	495	443	229
46	73.6	60	83.5	64.8	50.3	458	480	432	221
45	73.1	59.2	83.0	64.0	49.0	446	466	421	215
44	72.5	58.5	82.5	63.1	47.8	434	452	409	208
43	72.0	57.7	82.0	62.2	46.7	423	438	400	201
42	71.5	56.9	81.5	61.3	45.5	412	426	390	195
41	70.9	56.2	80.9	60.4	44.3	402	414	381	188
40	70.4	55.4	80.4	59.5	43.1	392	402	371	182
39	69.9	54.6	79.9	58.6	41.9	382	391	362	177
38	69.4	53.8	79.4	57.7	40.8	372	380	353	171
37	58.9	53.1	78.8	56.8	39.6	363	370	344	166
36	68.4	52.3	78.3	55.9	38.4	354	360	336	161
35	67.9	51.5	77.7	55.0	37.2	345	351	327	156
34	67.4	50.8	77.2	54.2	36.1	336	342	319	152
33	66.8	50.0	76.6	53.3	34.9	327	334	311	149
32	66.3	49.2	76.1	52.1	33.7	318	326	301	146
31	65.8	48.4	75.6	51.3	32.5	310	318	294	141
30	65.3	47.7	75.0	50.4	31.3	302	311	286	138
29	64.8	47.0	74.5	49.5	30.1	294	304	279	135
28	64.3	46.1	73.9	48.6	28.9	286	297	271	131
27	63.8	45.2	73.3	47.7	27.8	279	290	264	128
26	63.3	44.6	72.8	46.8	26.7	272	284	258	125
25	62.8	43.8	72.2	45.9	25.5	266	278	253	123
24	62.4	43.1	71.6	45.0	24.3	260	272	247	119
23	62.0	42.1	71.0	44.0	23.1	254	266	243	117
22	61.5	41.6	70.5	43.2	22.0	248	261	237	115
21	61.0	40.9	69.9	42.3	20.7	243	256	231	112
20	60.5	40.1	69.4	41.5	19.6	238	251	226	110

Hardness values in brackets are outside the range recommended for Brinell testing in ASTM E-10.

The above table is from ASTM E-110 except values for E-scale and Tensile Strength which are not from or according to ASTM Standards.

10.5 Hardness Conversion Chart, Rockwell B Hardness Range

Rockwell B Hardness Range

Approximate Hardness Conversion Numbers for Non-Austenitic Steels, according to ASTM E-140
The conversion values contained herein should be considered approximate only and may be inaccurate for Specific applications.

B	Rockwell A	Rockwell E	Superficial 15T	Superficial 30T	Superficial 45T	Vickers	Knoop	Brinell	Tensile	Brinell
100kgf	60 kgf	100 kgf	15 kgf	30 kgf	45 kg f	Hardness	Hardness	Hardness	Strength	Hardness
1/16"ball	diamond	1/8" ball	1/16" ball	1/16"ball	1/16" ball		500gf and over	3000 kgf 10mm ball	1000 lbs/ square in	500 kgf 10mm ball
100	61.5		93.1	83.1	72.9	240	261	240	116	201
99	60.9		82.8	82.5	71.9	234	246	234	114	195
98	60.2		92.5	81.8	70.9	228	241	228	109	189
97	59.5		92.1	81.1	69.9	222	236	222	105	184
96	58.9		91.8	80.4	68.9	216	231	216	102	179
95	58.3		91.5	79.8	67.9	210	226	210	100	175
94	57.6		91.2	79.1	66.9	205	221	205	98	171
93	57		90.8	78.4	65.9	200	216	200	94	167
92	56.4		90.5	77.8	64.8	195	211	195	92	163
91	55.8		90.2	77.1	63.8	190	206	190	90	160
90	55.2		89.9	76.4	62.8	186	201	186	89	157
89	54.6		89.5	76.8	61.8	180	196	180	88	164
88	64.0		89.2	75.1	60.8	176	192	176	86	151
87	53.4		88.9	74.4	59.8	172	188	172	84	148
86	52.8		88.6	73.8	58.8	169	184	169	83	145
85	52.3		88.2	73.1	57.8	165	180	165	82	142
84	51.7		87.9	72.4	56.8	162	176	162	81	140
83	51.1		87.6	71.8	55.8	159	173	159	80	137
82	50.6		87.3	71.1	54.8	156	170	156	76	135
81	50		86.9	70.4	53.8	153	167	153	73	133
80	49.5		86.6	69.7	52.8	150	164	150	72	130
79	48.9		86.3	69.1	51.8	147	161	147	70	128
78	48.4		86.0	68.4	50.8	144	158	144	69	126
77	47.9		85.6	67.7	49.8	141	155	141	68	124
76	47.3		85.3	67.1	48.8	139	152	139	67	122
75	46.8		86.0	66.4	47.8	137	150	137	66	120
74	46.3		84.7	65.7	46.8	135	147	135	66	118
73	45.8		84.3	65.1	45.8	132	145	132	64	116
72	45.3		84.0	64.4	44.8	130	143	130	63	114
71	44.8	100	83.7	63.7	43.8	127	141	127	62	112
70	44.3	99.5	83.4	63.1	42.8	125	139	125	61	110
69	43.8	99.0	83.0	62.4	41.8	123	137	123	60	109
68	43.3	98.0	82.7	61.7	40.8	121	135	121	59	108
67	42.8	97.5	82.4	61	39.8	119	133	119	58	106
66	42.3	97.0	82.1	60.4	38.7	117	131	117	57	104
65	41.8	96.0	81.8	59.7	37.7	116	129	116	56	102
64	41.4	95.5	81.4	59	36.7	114	127	114		100
63	40.9	95.0	81.1	58.4	35.7	112	125	112		99
62	40.4	94.5	80.8	57.7	34.7	110	124	110		98
61	40.0	93.5	80.5	57.0	33.7	108	122	108		96
60	39.5	93.0	80.1	56.4	32.7	107	120	107		95
59	39.0	92.5	79.8	55.7	31.7	106	118	106		94
58	38.6	92.0	79.5	55	30.7	104	117	104		92
57	38.1	91.0	79.2	54.4	2.97	103	115	103		91
56	37.7	90.6	78.8	53.7	28.7	101	114	101		90
55	37.2	90.0	78.6	53.0	27.7	100	112	100		89
54	36.8	89.5	78.2	52.4	26.7		111			87
53	36.3	89.0	77.9	51.7	26.7		110			86
52	35.9	88.0	77.5	51.0	24.7		109			85
51	35.5	87.6	77.2	50.3	23.7		108			84
50	35.0	87.0	76.9	49.7	22.7		107			83
49	34.6	86.5	76.6	49.0	21.7		106			82
48	34.1	85.5	76.2	48.3	20.7		105			81
47	33.7	85	75.9	47.7	19.7		104			80
46	33.3	84.6	76.6	47.0	18.7		103			80
45	32.9	84	76.3	46.3	17.7		102			79
44	32.4	83.5	74.9	45.7	16.7		101			78
43	32.0	82.5	74.6	45.0	15.7		100			77
42	31.6	82	74.3	44.3	14.7		99			76
41	31.2	81.5	74.0	43.7	13.6		98			75
40	30.7	81	73.6	43.0	12.6		97			75
39	30.3	80	73.3	42.3	11.6		96			74
38	29.9	79.5	73.0	41.6	10.6		95			73
37	29.5	79	72.7	41.0	9.6		94			72
36	29.1	78.5	72.3	40.3	8.6		93			72
35	28.7	78.0	72.0	39.6	7.6		92			71
34	28.2	77.0	71.7	39.0	6.6		91			70
33	27.8	76.6	71.4	38.3	5.6		90			69
32	27.4	76.0	71.0	37.6	4.6		89			69
31	27.0	75.5	70.7	37.0	3.6		88			68
30	26.6	75.0	70.4	36.3	2.6		87			67

Chart reprinted from ASTM Handbook

10.6 Test Blocks Hardness Ranges (Indirect Verification)

**Maximum Allowable repeatability and Error of Testing Machines
for Ranges of Standardized Test Blocks**

	Range of Standardized Test Blocks ^A	Maximum Repeatability, <i>R</i> (HR units)	Maximum Error, <i>E</i> (HR units)
HRA	< 70	2.0	± 1.0
	\$ 70 and < 80	1.5	± 1.0
	\$ 80	1.0	± 0.5
HRBW	< 60	2.0	± 1.5
	\$ 60 and < 80	1.5	± 1.0
	\$ 80	1.5	± 1.0
HRC	< 35	2.0	± 1.0
	\$ 35 and < 60	1.5	± 1.0
	\$ 60	1.0	± 0.5
HRD	< 51	2.0	± 1.0
	\$ 51 and < 71	1.5	± 1.0
	\$ 71	1.0	± 0.5
HREW	< 84	1.5	± 1.0
	\$ 84 and < 93	1.5	± 1.0
	\$ 93	1.0	± 1.0
HRFW	< 80	1.5	± 1.0
	\$ 80 and < 94	1.5	± 1.0
	\$ 94	1.0	± 1.0
HRGW	< 55	2.0	± 1.0
	\$ 55 and < 80	2.0	± 1.0
	\$ 80	2.0	± 1.0
HRHW	< 96	2.0	± 1.0
	\$ 96	2.0	± 1.0
HRKW	< 65	1.5	± 1.0
	\$ 65 and < 85	1.0	± 1.0
	\$ 85	1.0	± 1.0
HRLW ^B		2.0	± 1.0
HRMW ^B		2.0	± 1.0
HRPW ^B		2.0	± 1.0
HRRW ^B		2.0	± 1.0
HRSW ^B		2.0	± 1.0
HRVW ^B		2.0	± 1.0
HR15N	< 78	2.0	± 1.0
	\$ 78 and < 90	1.5	± 1.0
	\$ 90	1.0	± 0.7
HR30N	< 55	2.0	± 1.0
	\$ 55 and < 77	1.5	± 1.0
	\$ 77	1.0	± 0.7
HR45N	< 37	2.0	± 1.0
	\$ 37 and < 66	1.5	± 1.0
	\$ 66	1.0	± 0.7
HR15TW	< 81	2.0	± 1.5
	\$ 81 and < 87	1.5	± 1.0
	\$ 87	1.5	± 1.0
HR30TW	< 57	2.0	± 1.5
	\$ 57 and < 70	1.5	± 1.0
	\$ 70	1.5	± 1.0
HR45TW	< 33	2.0	± 1.5
	\$ 33 and < 53	1.5	± 1.0
	\$ 53	1.5	± 1.0
HR15WW ^B		2.0	± 1.0
HR30WW ^B		2.0	± 1.0
HR45WW ^B		2.0	± 1.0
HR15XW ^B		2.0	± 1.0
HR30XW ^B		2.0	± 1.0
HR45XW ^B		2.0	± 1.0
HR15YW ^B		2.0	± 1.0
HR30YW ^B		2.0	± 1.0
HR45YW ^B		2.0	± 1.0

^A The user may find that high, medium and low range test blocks are unavailable commercially for some scales. In these cases one or two standardized blocks where available may be used. It is recommended that all high range test blocks for Rockwell scales using a ball indenter should be less than 100 HR units.

^B Appropriate ranges of standardized test blocks for the L, M, P, R, S, V, W, X, and Y scales shall be determined by dividing the usable range of the scale into two ranges, if possible.

Chart reprinted from ASTM Handbook

APPENDIX A: AT130-MT2 (-N or -T) Electric Motor Drive Option

This tester uses an electric motor assembly, mounted to the top of the stand, to apply test loads.

After installing the test head, connect the cables from the motor assembly to the back of the tester readout unit. Each connector end is keyed so that only the proper male and female ends will fit (see *Rear Connections* image, section 4.5).

The test cycle is activated by pressing the Remote Start Switch “*Pedal*”.

If the tester does not cycle properly or does not apply full load, check the positioning of the actuating arm assembly as indicated in the drawings.



NOTE: Disconnect the Tester from the power supply before removing the motor cover.

APPENDIX B: AT130-MT4 (T-Stand) Automatic Head-Height Adjustment Option

Testers supplied with a motorized head height adjustment option can move the top of the tester and test head up or down automatically to accommodate testing on parts that vary greatly in size.

The control box has 4 controls

1. To turn on, turn arrow knob to brake position, plug in the power cord and flip the ON/OFF toggle switch to ON. The power light will come on.
2. Turn the knob to “Lower” for downward travel, “Raise” for upward travel. Release knob to stop motion.
3. Place specimen on anvil or anvil stage, and practice clamping the specimen and unclamping it. Adjust torque and speed settings to desired levels.
4. Avoid running the height all the way up. If it gets stuck at this position, turn torque to “OFF” and arrow knob to “Forward” to unstick.



CAUTION: The operator must be careful not to pinch his hand between test head and specimen or anvil. Serious operator injury may result.

APPENDIX C: Calibration & Service Support

Newage Testing Instrument's sales and service staff and our associates have the capability to support hardness testing needs anywhere in the world.

Additionally, Newage Versitron® test heads can be shipped to our Pennsylvania location for factory service.



We provide a loaner/rental program for some models (subject to availability) to keep our customers in operation while their test heads are serviced.

For details call 800-806-3924 (or 215-355-6900 in Pennsylvania and outside the US).

Here is what you can expect from the Newage Service Network:

- For emergency service, you'll receive a fast, on-site response by a qualified technician.
- Standardized procedures with detailed documentation that will pass your internal and external audits.
- Verification, calibration, preventive maintenance, and repairs on many different types of hardness testing systems, regardless of make and model. Newage stocks commonly used spare parts for testers from other manufacturers.
- All vehicles and service personnel are fully insured for liability for on-site service at your facility.
- Call 800-317-1976 to schedule on-site service of your hardness tester.
- Call 800-806-3924 to get answers to questions in any area of hardness testing, or receive engineering assistance on any hardness testing application. (Call 215-355-6900 in Pennsylvania or outside the US).

ONE YEAR LIMITED WARRANTY

Should Newage Testing Instruments, Inc. equipment require service, we will repair or replace, at our option, any part or product which upon examination by a Newage service technician, shows to be defective in material or workmanship.

Excluded from this warranty are any parts that are to be replaced as part of normal product operation, such as indenters, test blocks, and indenter shrouds.

This warranty is extended to the original purchaser only, for a period of one year (12 months) from owner's date of purchase.

This warranty IS NOT VALID IF THE INSTRUMENT HAS BEEN MODIFIED, MISUSED OR DAMAGED in any way. This includes damage caused by disassembly by any person other than an authorized Newage Testing Instruments' service technician.

Please read all operating instructions according to the manual supplied with the instrument prior to operation. This warranty applies only to instruments sold by Newage Testing Instruments, Inc. and its authorized distributors.

Newage Testing Instruments, Inc. is not responsible in any way for losses, damage, or other form of consequential damage resulting from equipment failure or improper use.

IMPORTANT: Register your instrument with Newage Testing Instruments, Inc. service department by filling out and returning the enclosed warranty registration card



www.hardnesstesters.com

Newage Testing Instruments, Inc.
820 Pennsylvania Blvd • Feasterville • PA 19053 • USA
Tel: 215-355-6900 • Fax: 215-354-1803
Newage.info@ametek.com

AMETEK Denmark (Scandinavia)
Tel +45 4816 8000 • ametek@ametek.dk

Lloyd Instruments Ltd. (UK)
Tel +44 (0) 1243 833 370 • uk-far.general@ametek.com.uk

AMETEK SAS (France)
Tel +33 (0) 1 30 68 89 40 • info.lloyd-instruments@ametek.fr

AMETEK Europe GmbH (Germany)
Tel +49 0 2159 9136 70 • apie@ametek.de

AMETEK Singapore Pvt. Ltd. (Singapore)
Tel +65 484 2388 • aspl@ametek.com.sg

Information in this document is subject to change without notice. ©2011 by AMETEK, Inc., www.ametek.com. All rights reserved